



Metropolitan Water Reclamation District of Greater Chicago

**Welcome to the July Edition
of the 2023 M&R Seminar
Series**

NOTES FOR SEMINAR ATTENDEES

- Remote attendees' audio lines have been muted to minimize background noise. **For attendees in the auditorium, please silence your phones.**
- A question and answer session will follow the presentation.
- For remote attendees, Please use the "**Chat**" feature to ask a question via text to "**Host**". **For attendees in the auditorium, please raise your hand and wait for the microphone to ask a verbal question.**
- The presentation slides will be posted on the MWRD website after the seminar.
- This seminar has been approved by the ISPE for one PDH and approved by the IEPA for one TCH. Certificates will only be issued to participants who attend the entire presentation.

Mark Miller, Ph.D., P.E.
Senior Process Engineer
Brown and Caldwell



Mark Miller is a senior process engineer with Brown and Caldwell based out of Charlotte, North Carolina. He received a Bachelor of Science in Civil Engineering from Virginia Military Institute, and Master of Science and Ph.D. from Virginia Polytechnic Institute and State University.

His technical expertise includes enhanced biological nitrogen and phosphorus removal, high-rate activated sludge processes, whole-plant modeling, process automation, and treatment optimization. Mark also specializes in field work to characterize waste streams, diagnose treatment issues, and support designs to improve treatment processes.

Don Esping, P.E.
Senior Process Engineer
Brown and Caldwell



Don Esping is a professional engineer with over 30 years of experience in wastewater process evaluations and designs. He serves as Brown and Caldwell's Wastewater Process Engineering National Service Leader and Great Lakes Area Senior Process Engineer. He received a Bachelor of Science in Civil Engineering from the University of Minnesota and Master of Science in Civil Engineering from University of California-Berkeley.

His work focuses on evaluation and design of biological nutrient removal systems, auxiliary wet weather treatment systems, aeration systems, and plant capacity assessments.



Mark Miller, PhD, PE
704.373.7131
MMiller1@BrwnCald.com

Don Esping, PE
651.206.7936
DEsping@BrwnCald.com

More Than Just Energy Savings: Understanding the Benefits of Low DO Operation

Friday, July 28, 2023



Agenda

1. Background
2. Low DO Kinetics and Microbial Communities
3. Aeration Control Strategies
4. Low DO Case Studies
5. Q&R

The Problem

Wastewater has lots of organics and ammonia!

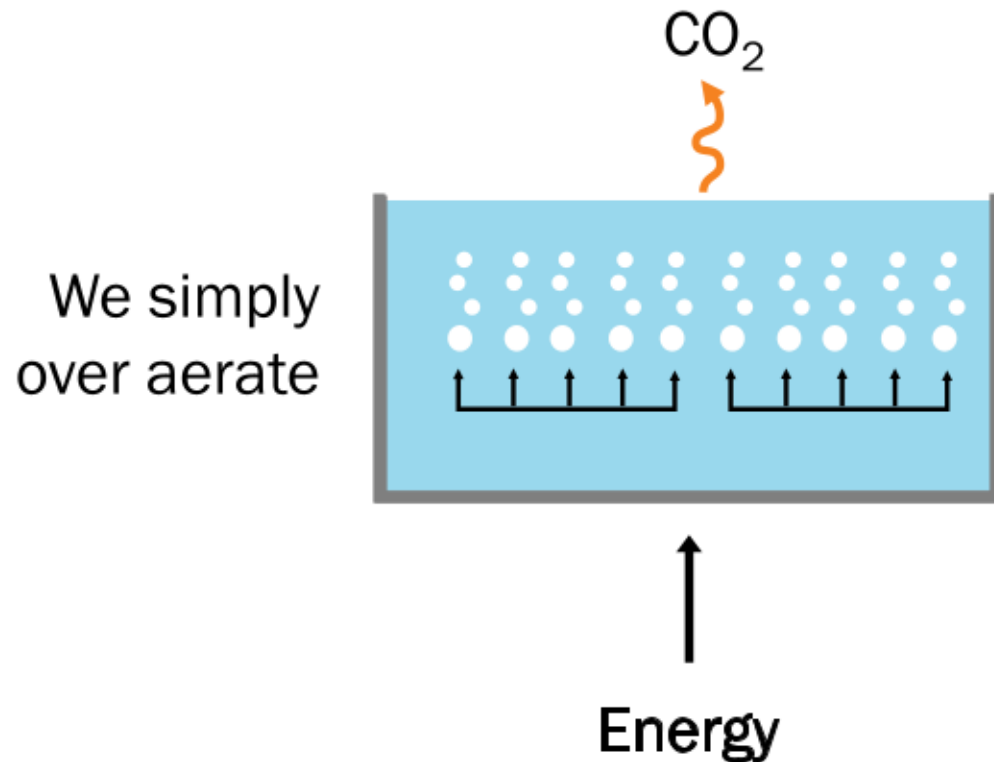

Consequences

- High energy demand
- Limited carbon available for nutrient removal
- Chemicals added for nutrient removal

Why high DO?

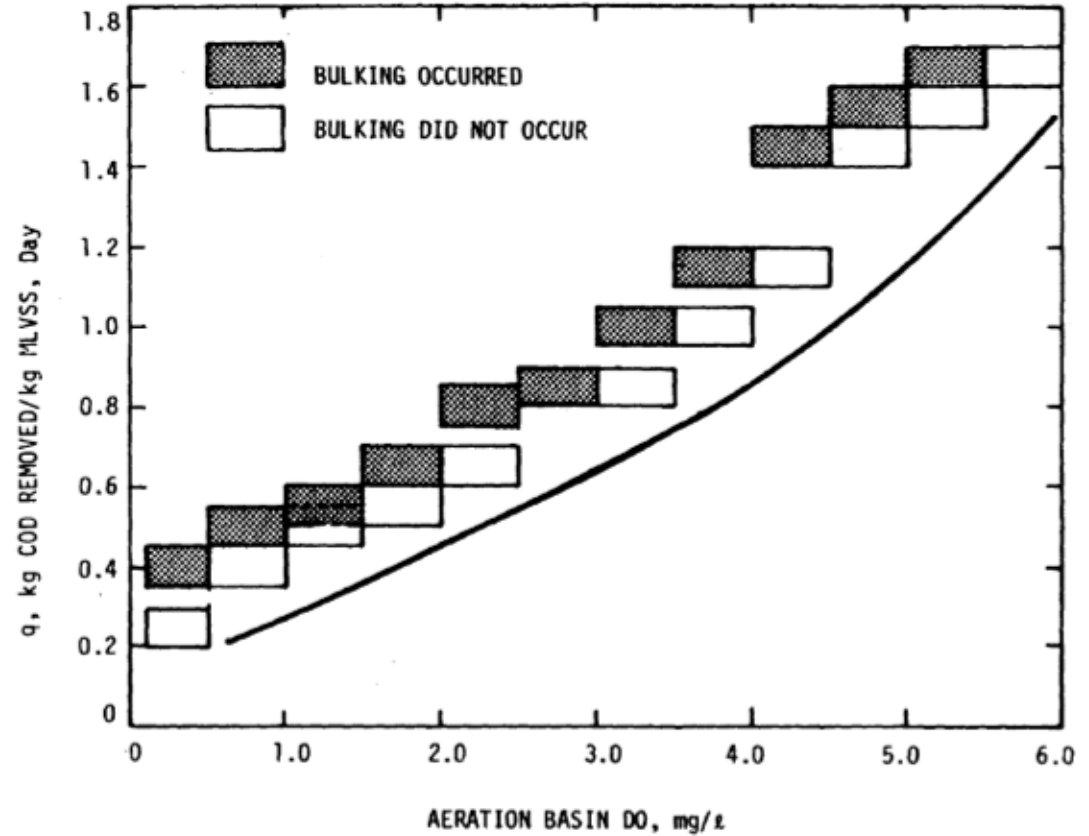
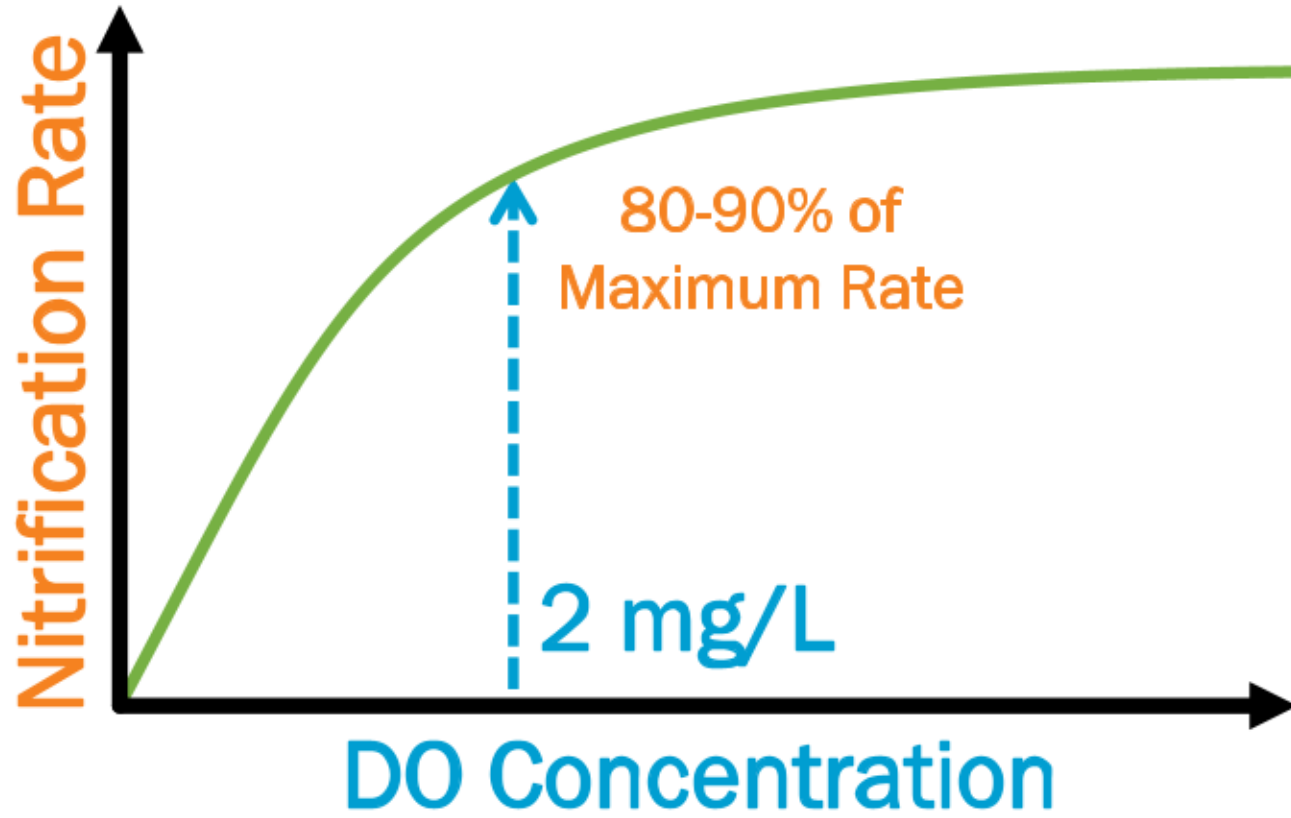

Palm et al. (1980) Relationship between organic loading rate, dissolved oxygen concentration, and sludge settleability in the completely-mixed activated sludge process. Journal WPCF, Vol. 52, No. 10.

Mechanical Benefits of Low DO Operation

- Lower diffuser flux results in higher oxygen transfer efficiencies
- Lower head losses in distribution piping and valving
- Allows operating at lower blower discharge pressures
- Higher driving force to dissolve oxygen into water

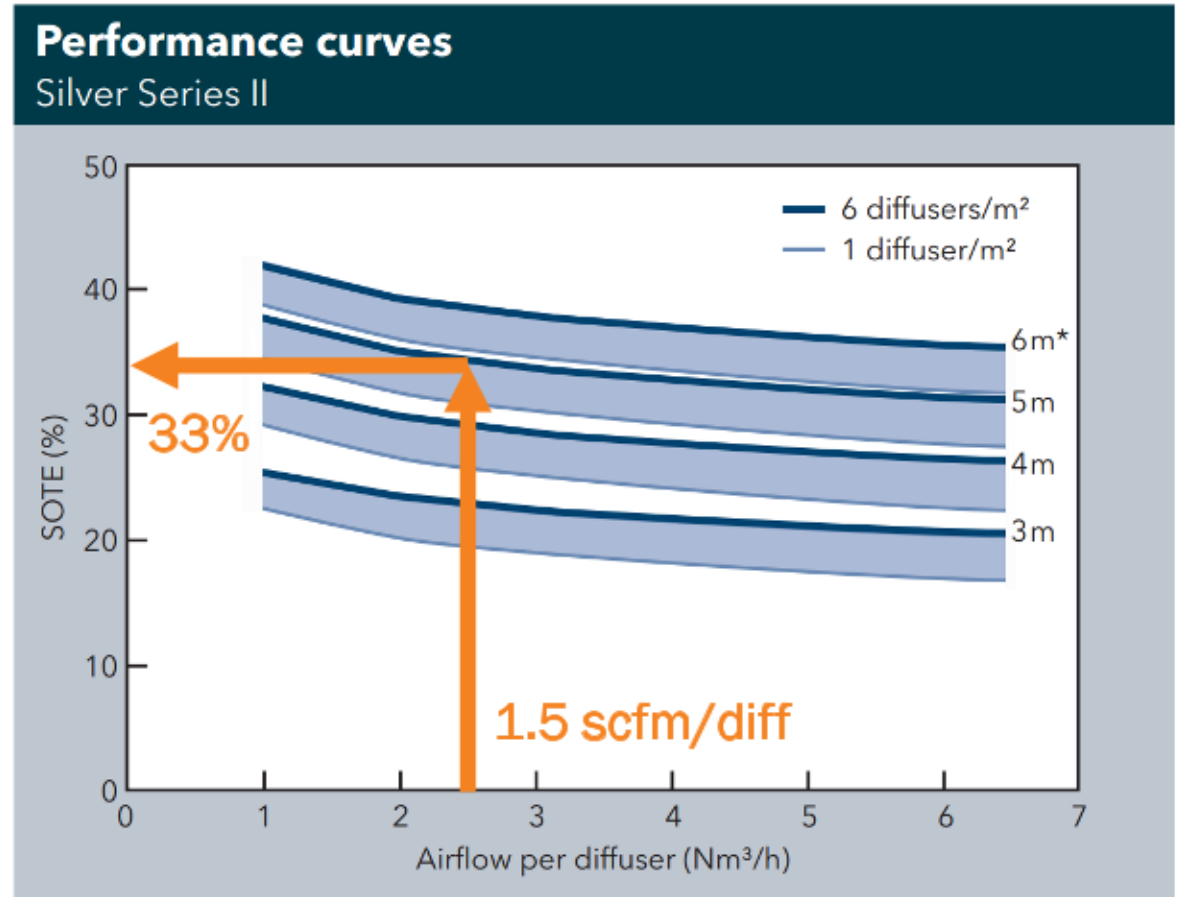

Xylem Aeration Products - Sanitaire Silver Series II Diffusers

*Submergence

Mechanical Benefits of Low DO Operation

- Lower diffuser flux results in higher oxygen transfer efficiencies
- Lower head losses in distribution piping and valving
- Allows operating at lower blower discharge pressures
- Higher driving force to dissolve oxygen into water

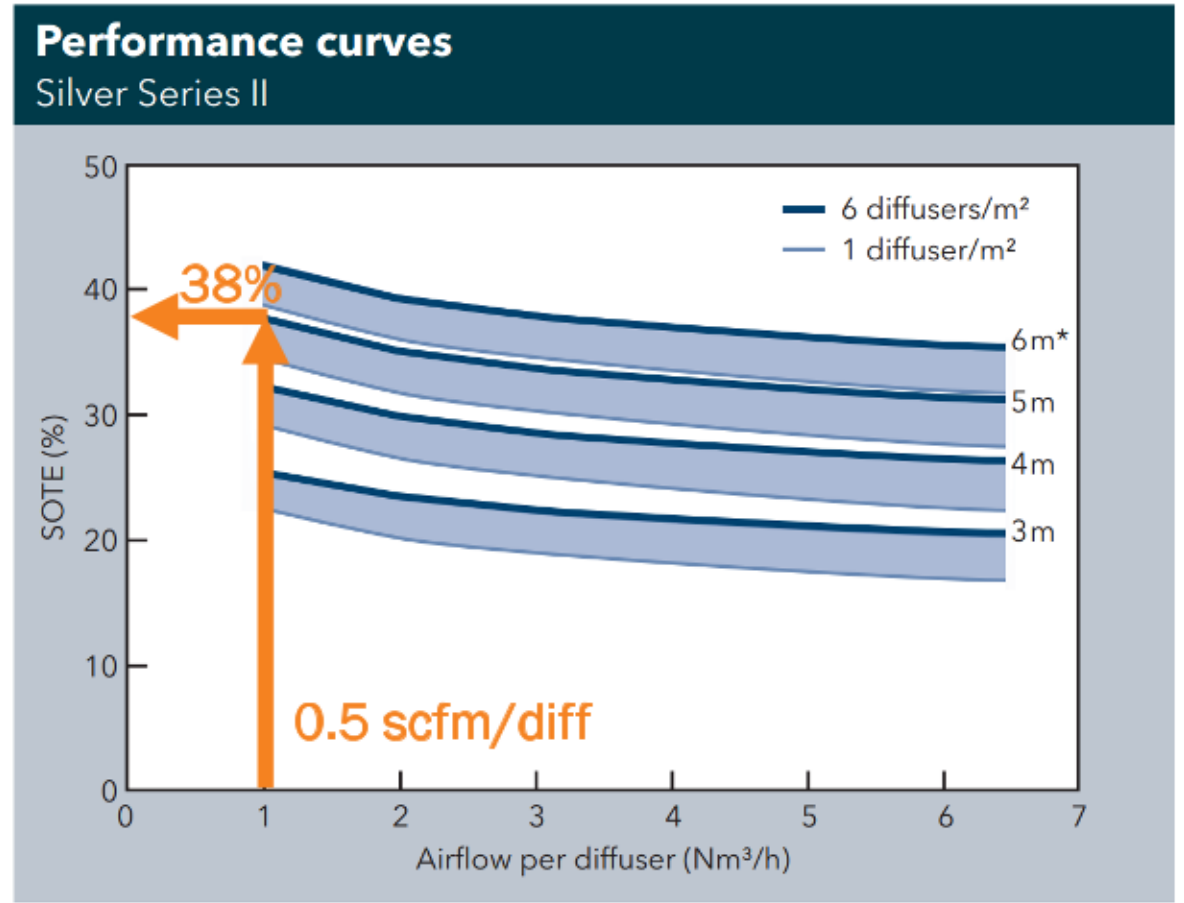

Xylem Aeration Products - Sanitaire Silver Series II Diffusers

*Submergence

Low DO-based Operation – Why is it important?

Benefits of Advanced Aeration Controls

- Energy savings
- Carbon and oxygen requirements are reduced
- Simultaneous nitrification and denitrification (SND)
- Simultaneous nitrogen and phosphorus removal

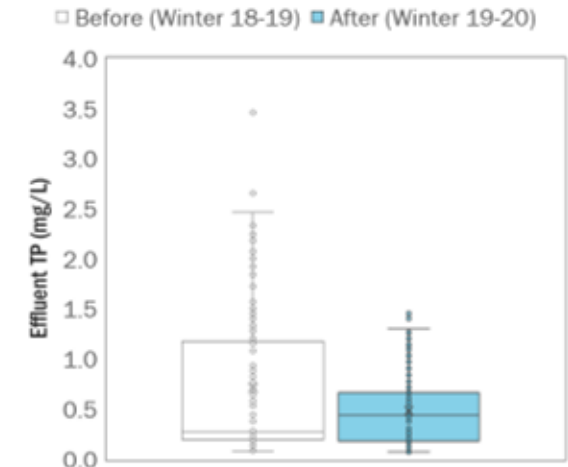
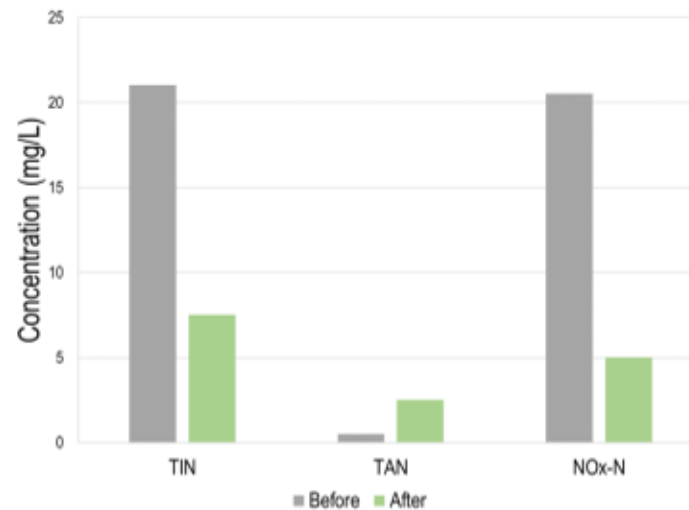

Low DO Kinetics and Microbial Communities



Kinetic Testing Campaign

Plant Type	Location	Temp. oC	aSRT days	Aeration Control	DO mgO ₂ /L
P1_A/O	Florida	27	4.2 ± 1.5	ABAC	0.2 ± 0.15
P2_A ₂ O	Colorado	20	8.1 ± 2.3	AvN	0.25 ± 0.20
P3_Bardenpho	Florida	25	18 ± 3.5	ORP	0.35 ± 0.25
P3B_Bardenpho	Florida	25	22 ± 2.0	ORP	0.35 ± 0.26
P4_Ditch - Bardenpho	Florida	25	12 ± 4.1	DO	0.30
P5_A/O - A ₂ O (Demo)	Minnesota	17	8.5 ± 1.7	ABAC - DO	0.30 ± 0.18
P6_Bardenpho (Demo)	Maryland	18	20.5 ± 4.5	ABAC	0.20 ± 0.15
P7_A/O (Demo)	California	19	6.5 ± 2.4	DO	0.5
P8_A/O	Florida	25	6.1 ± 2.6	ABAC	0.5
P9_Ditch - Bardenpho	Florida	25	16.2 ± 4.0	DO	0.35 ± 0.15
P10_MBR	Georgia	22	10.2 ± 3.5	DO	0.45
P11_Ditch - Bardenpho	Kansas	18	12.5 ± 2.5	DO	0.40 - 0.6
P12_Ditch - Bardenpho	Florida	25	16.5 ± 3.5	DO	0.30 ± 0.12
P12B_Ditch - Bardenpho	Florida	25	16.5 ± 3.6	DO	0.30 ± 0.13
P13_A/O	Texas	24	~ 15	DO	~ 0.6
P14_A/O (Pilot)	Kansas	19	~ 10	DO	~ 0.3
P15_A ₂ O	Wisconsin	16	~ 10	DO	0.5 - 2.0

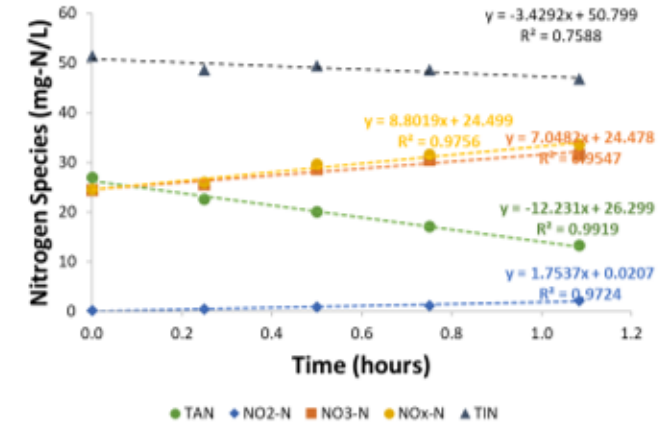

- Specific NH₃RR at low DO
- Maximum Specific NH₃RR
- Nitrifiers half-saturation coefficients (K_{D0})
- SND rate
- Microbial analysis
- N₂O emission (future)

*Data collected as part of WRF Project 5083

Nitrification Rates

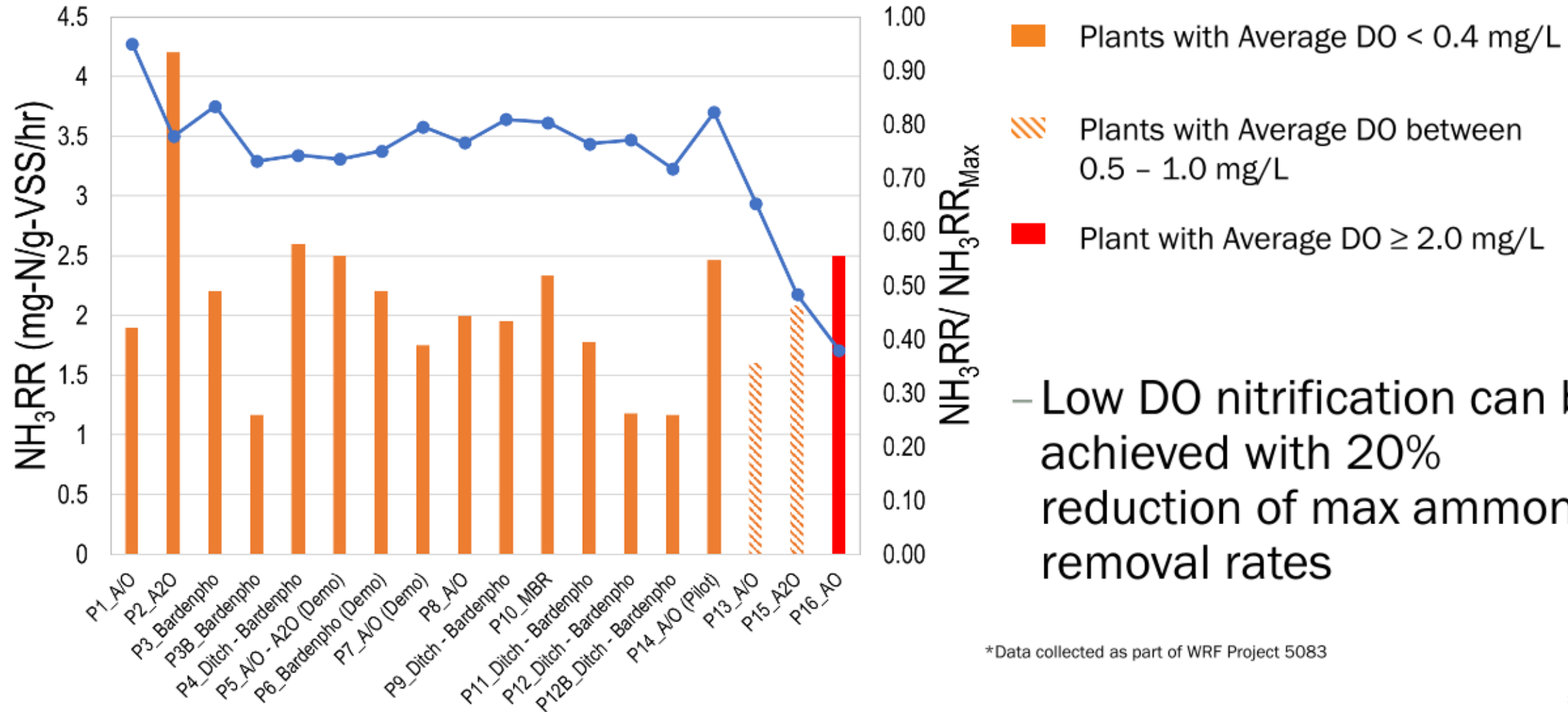

– Low DO nitrification can be achieved with 20% reduction of max ammonia removal rates

*Data collected as part of WRF Project 5083

Maximum Nitrification Rates

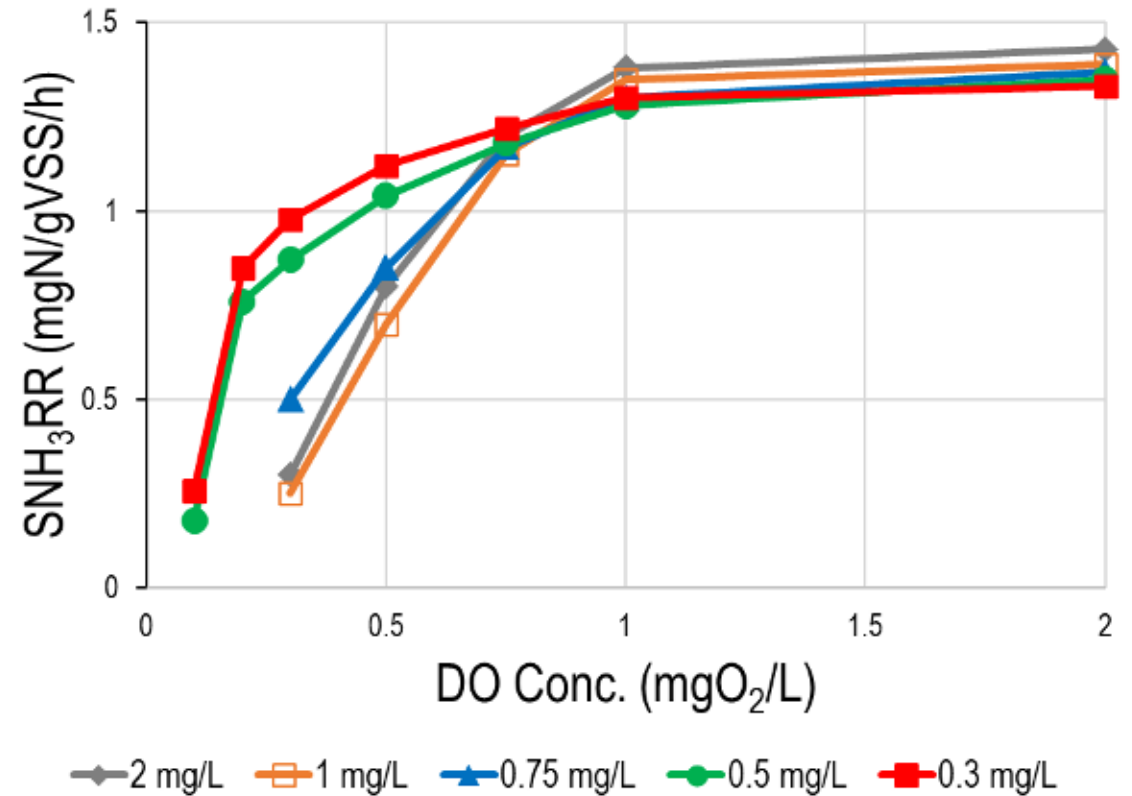
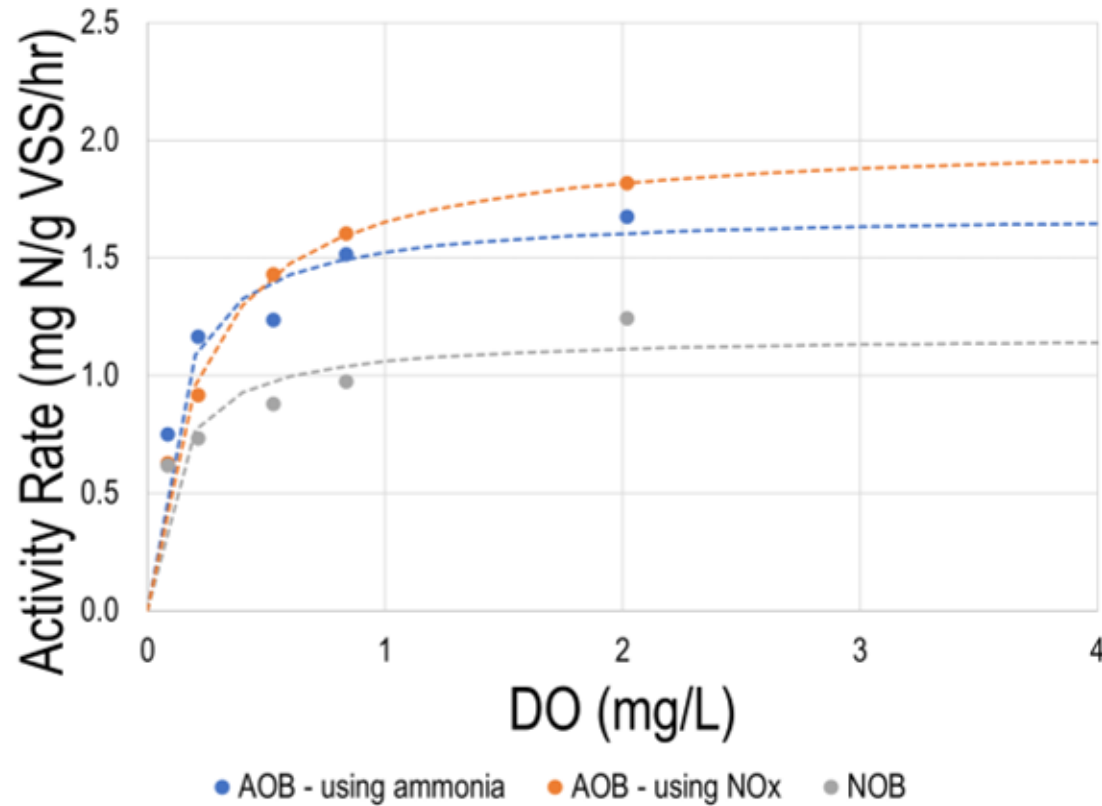

– Max rates not affected by low DO operation; hence, nitrification capacity is not reduced

*Data collected as part of WRF Project 5083

Nitrification K_{DO} Testing

- Sludge samples collected from full-scale facility at various DO setpoints after 2-3 weeks of acclimation at each DO setpoint
- Nitrification rate testing was performed at various DO concentrations (0-2 mg/L) in the batch reactor

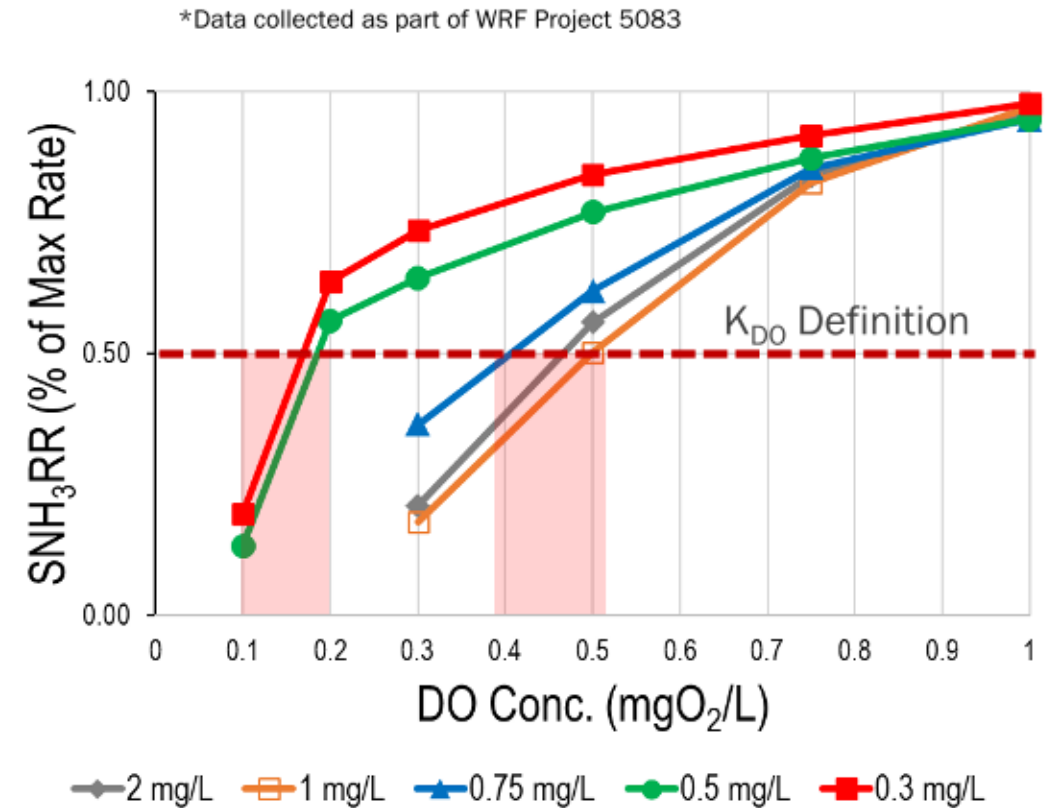
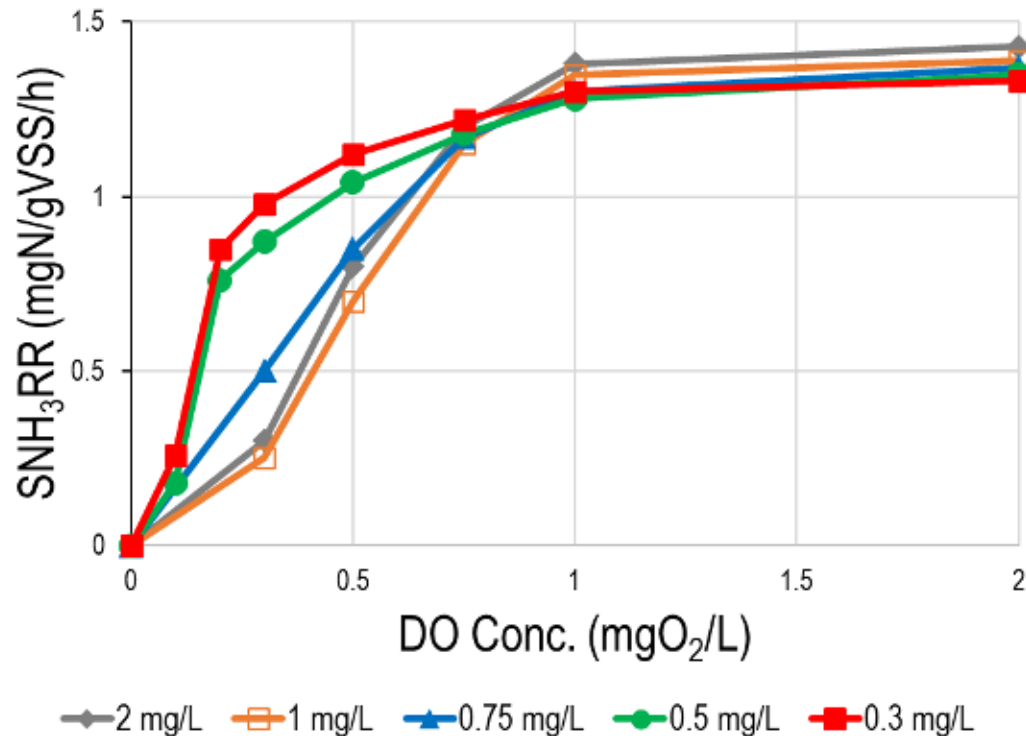

Nitrification K_{DO}

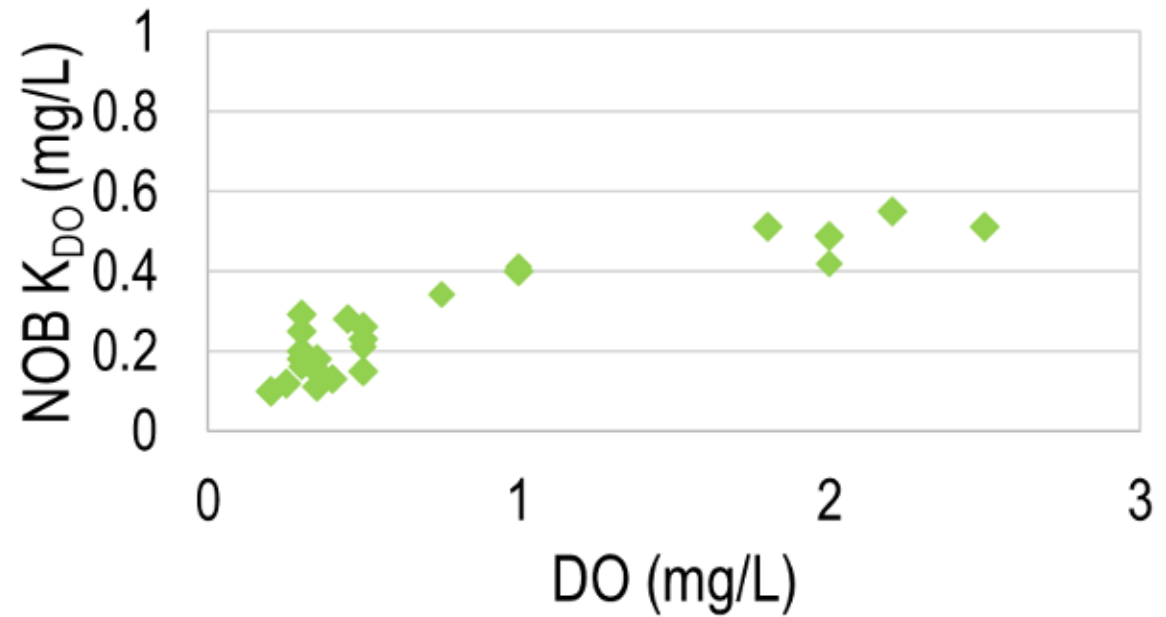
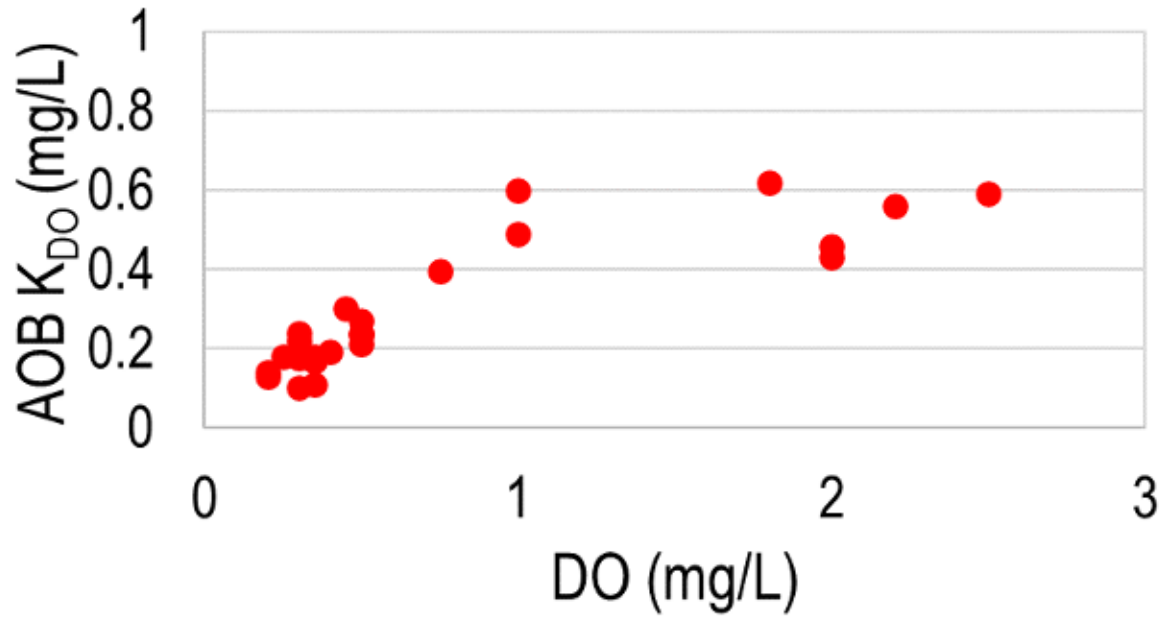

- High DO affinity at low DO conditions and the apparent K_{DO} decreases as DO decreases

*Data collected as part of WRF Project 5083

Biological Phosphorus Uptake Rates

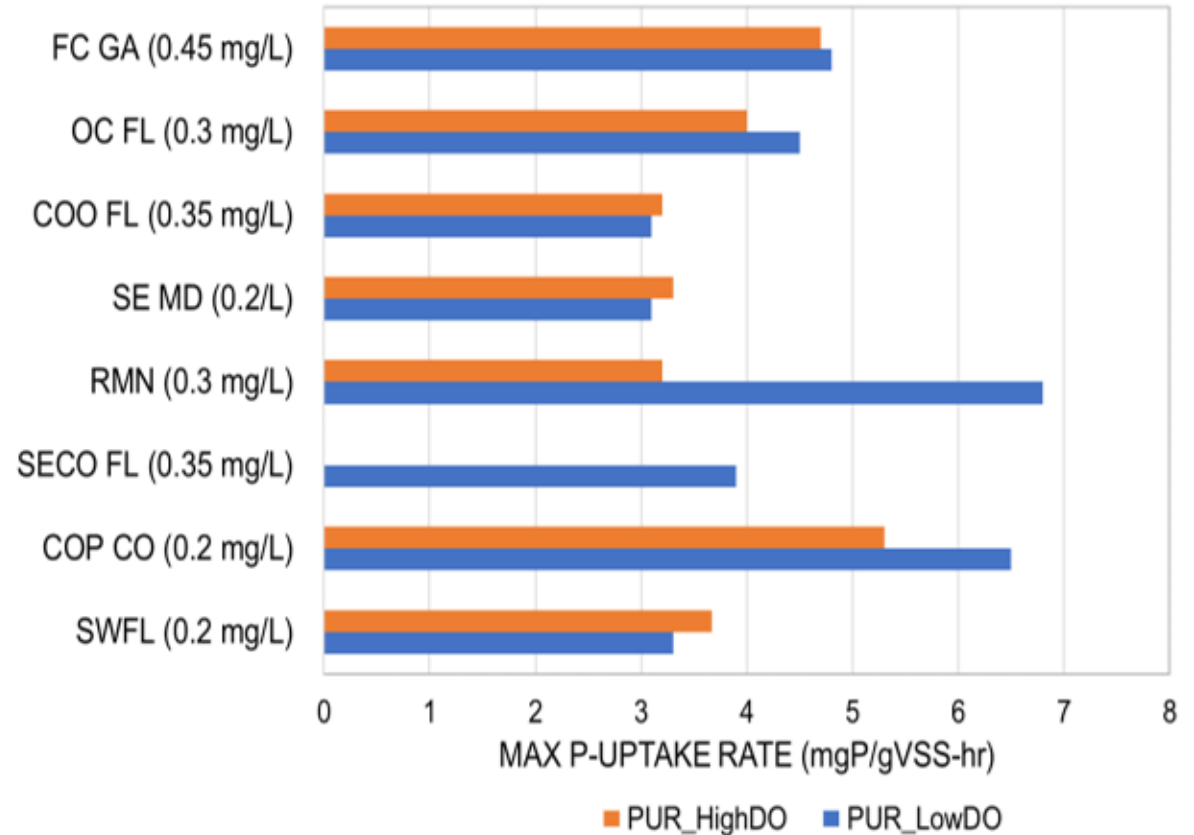
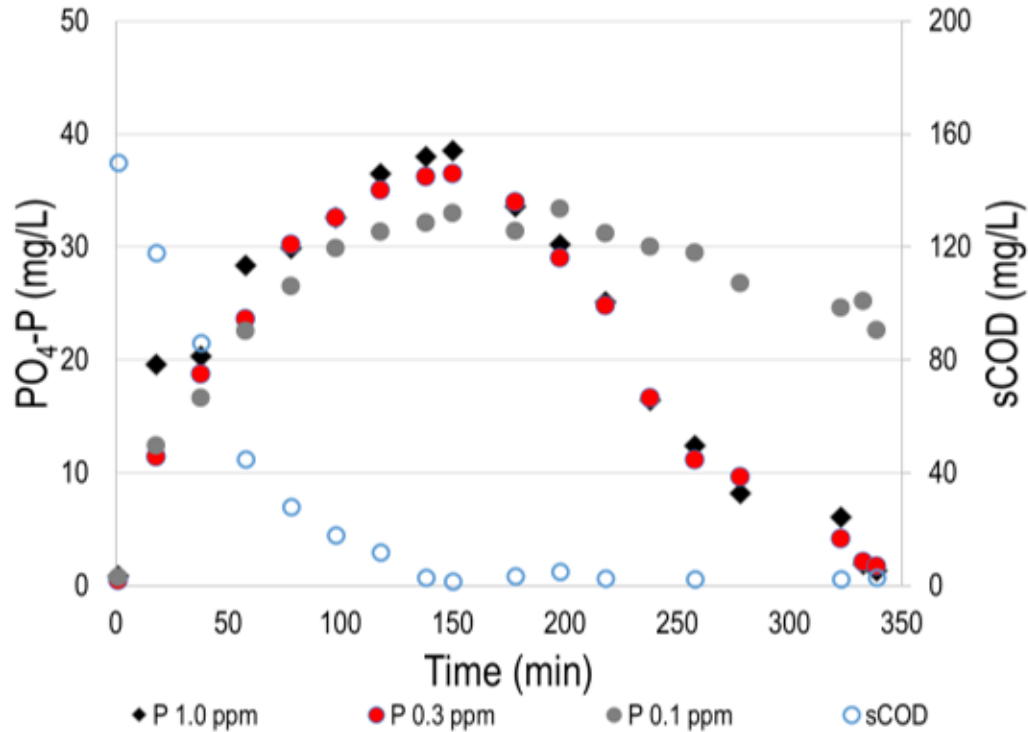

Rate (mgP/gVSS/hr)	High DO	Low DO
Max P Release	13.23 ± 1.92	14.16 ± 1.61
Max P Uptake	5.53 ± 1.85	6.52 ± 1.92
P:VFA	0.41 ± 0.05	0.56 ± 0.04

– Low DO seems to slightly improve PUR within the DO values evaluated

SND Efficiency

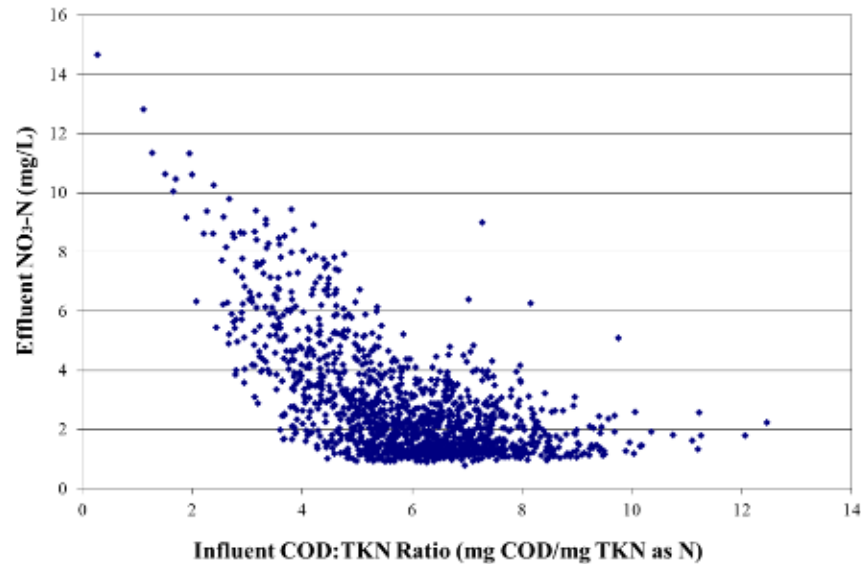
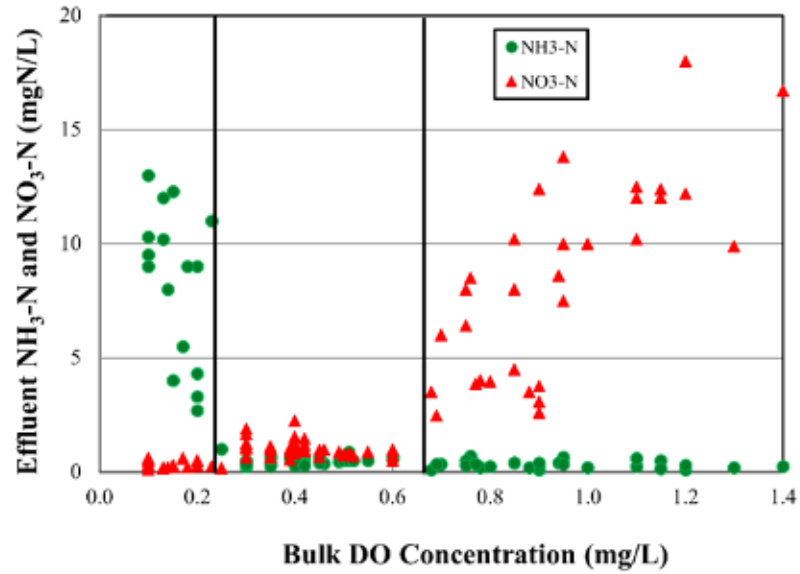

*Data collected as part of WRF Project 5083

TINRR (mg-N/g-VSS/hr)

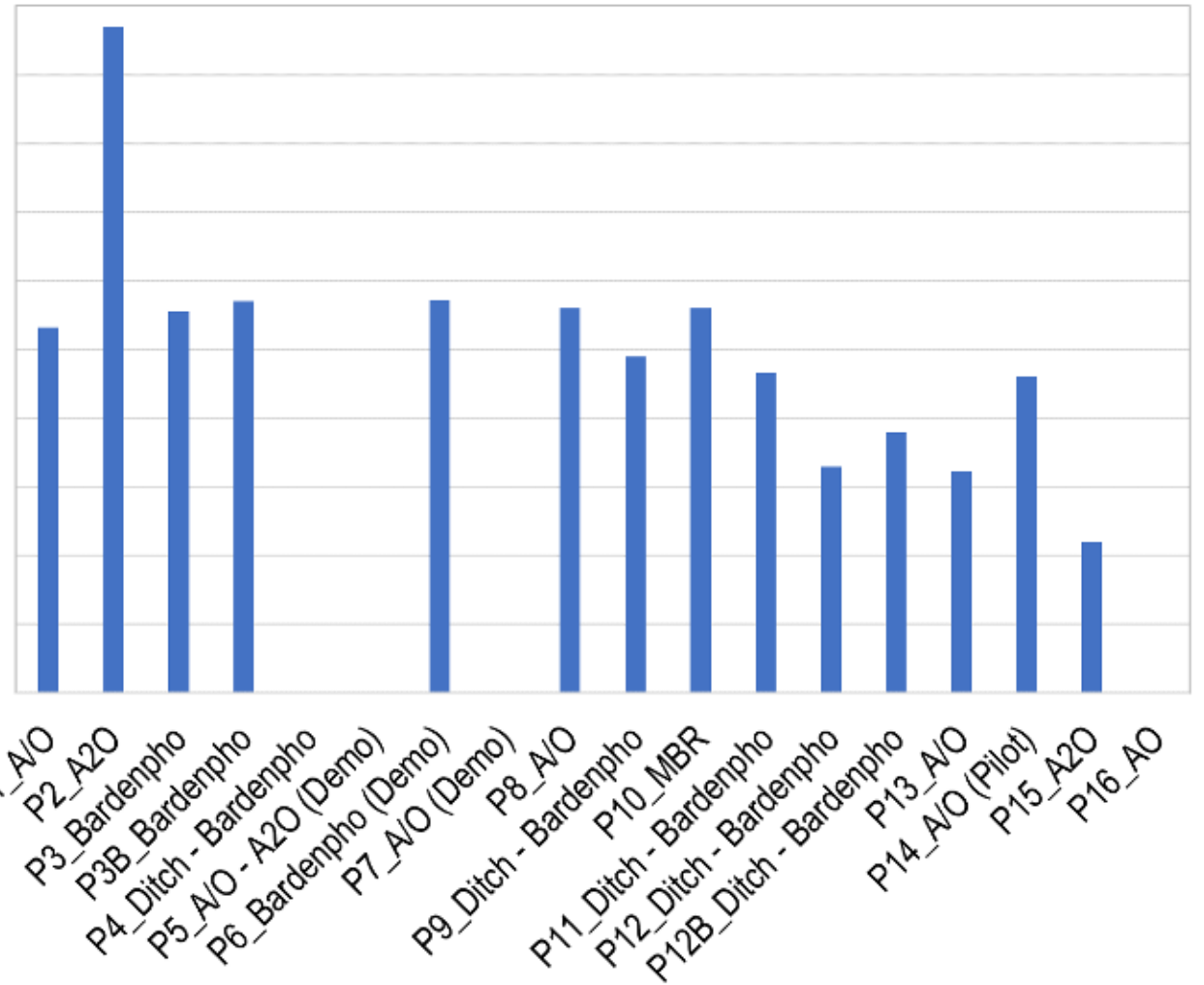

SND Rates

- SND occurs at DO concentrations less than 1 mg/L
- Must balance denitrification rates with nitrification rates
- Ideal DO range 0.2 to 0.7 mg/L

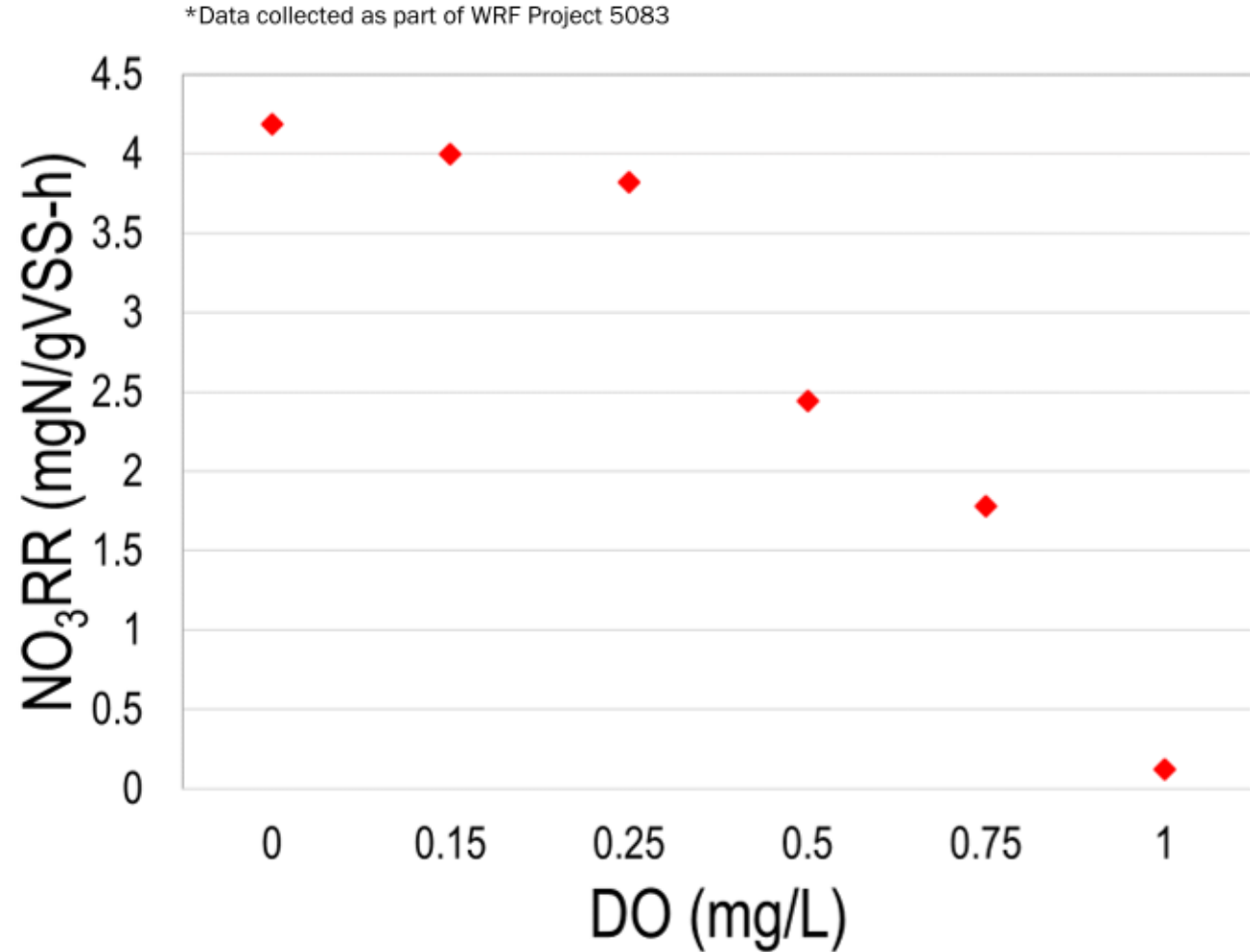

Apparent NOB Out-selection at Low DO

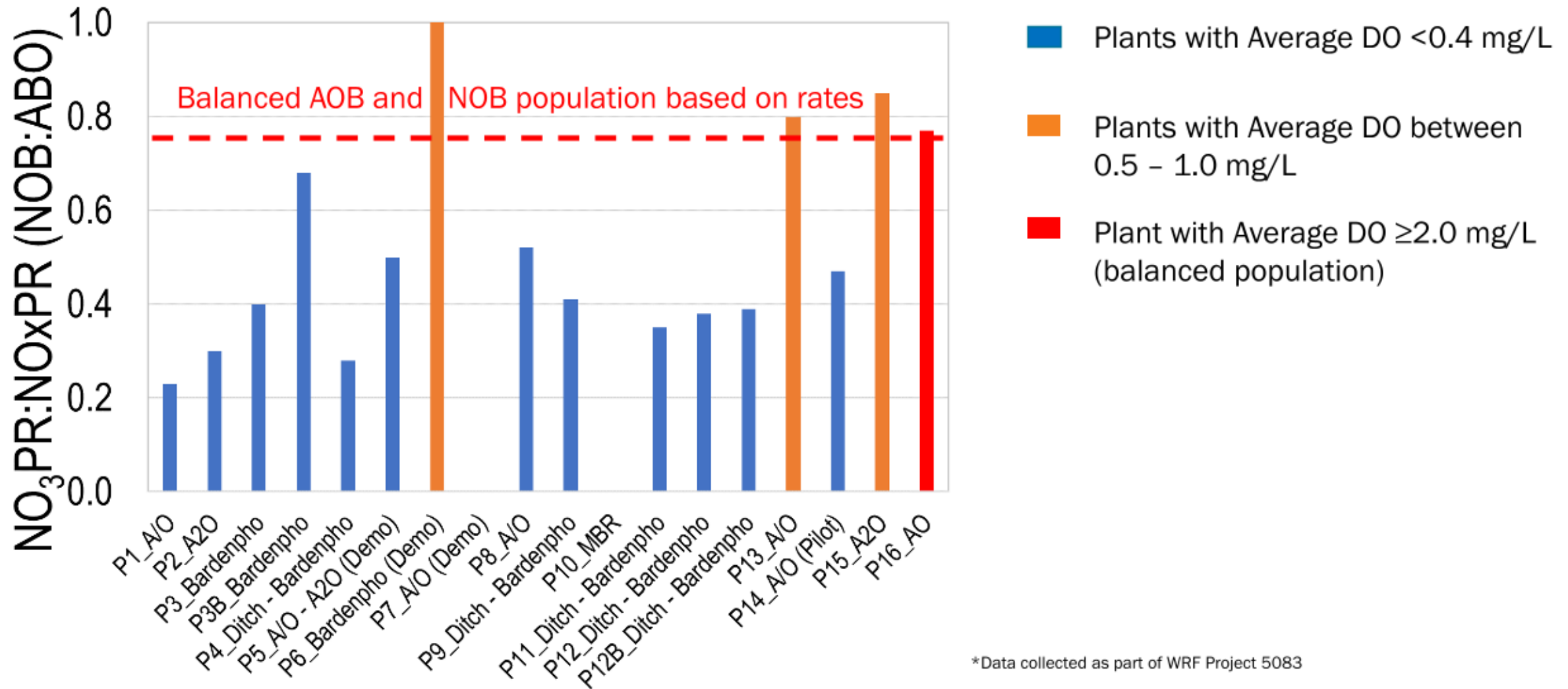

*Data collected as part of WRF Project 5083

Aeration Control Strategies



Diffused Aeration Control

- DO control with manual DO setpoints
- Ammonia based aeration control (ABAC)
- Ammonia versus NO_x-N (AvN) control
- Oxidation reduction potential (ORP) control

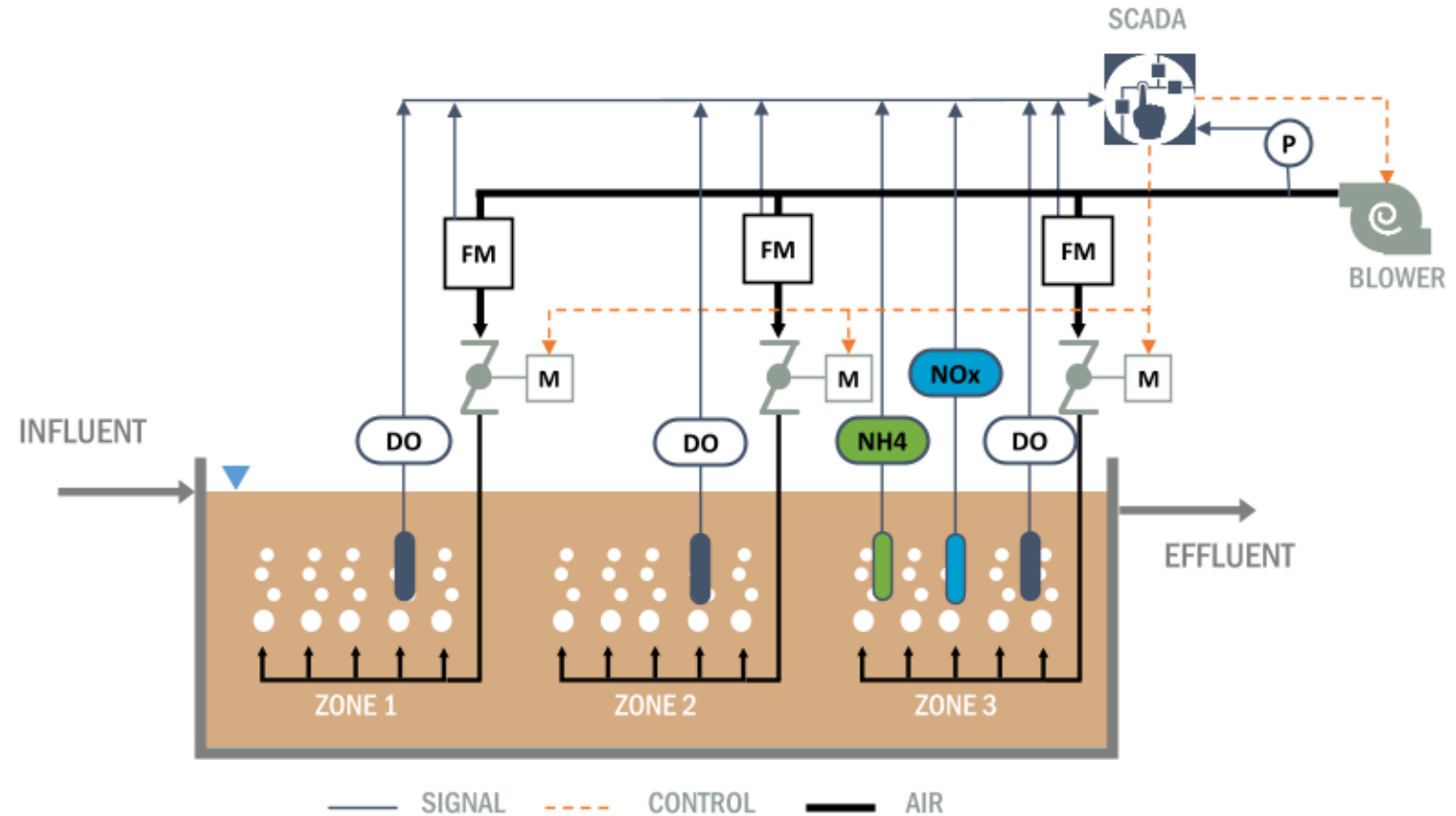

Cascading DO Control

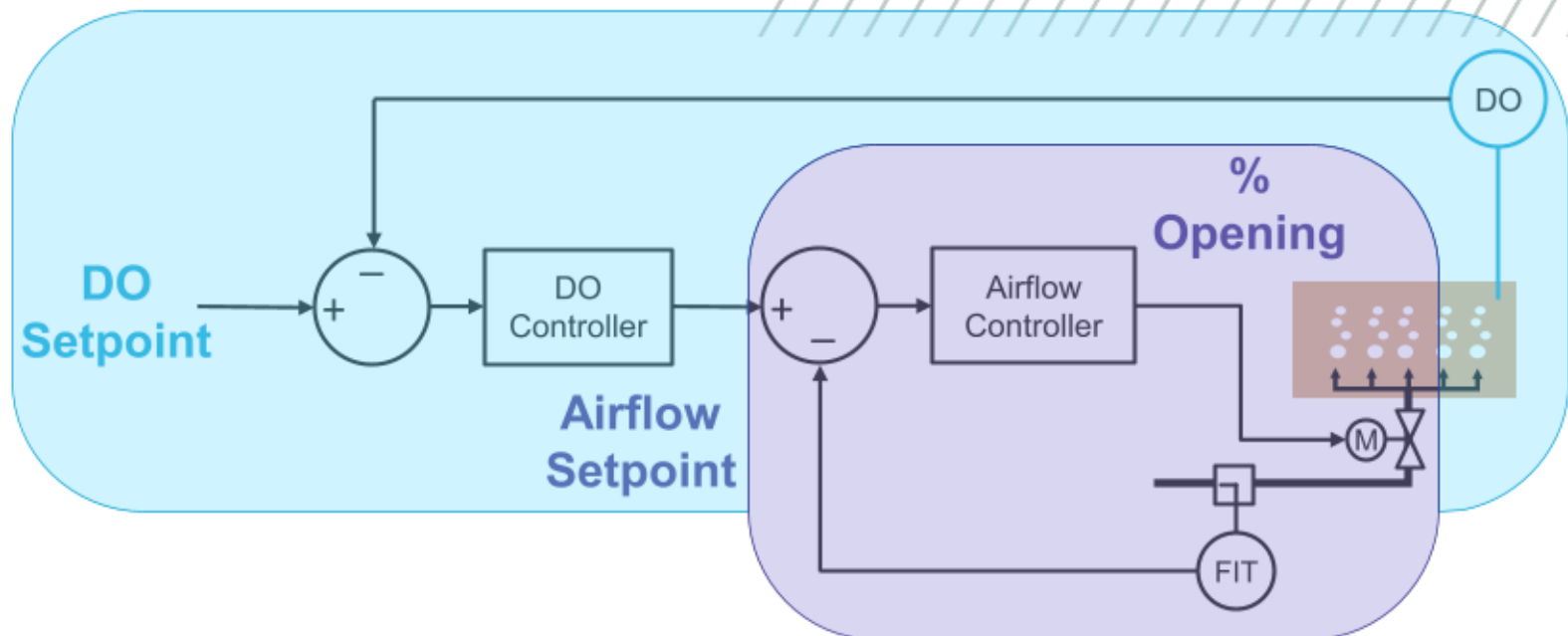

ABAC

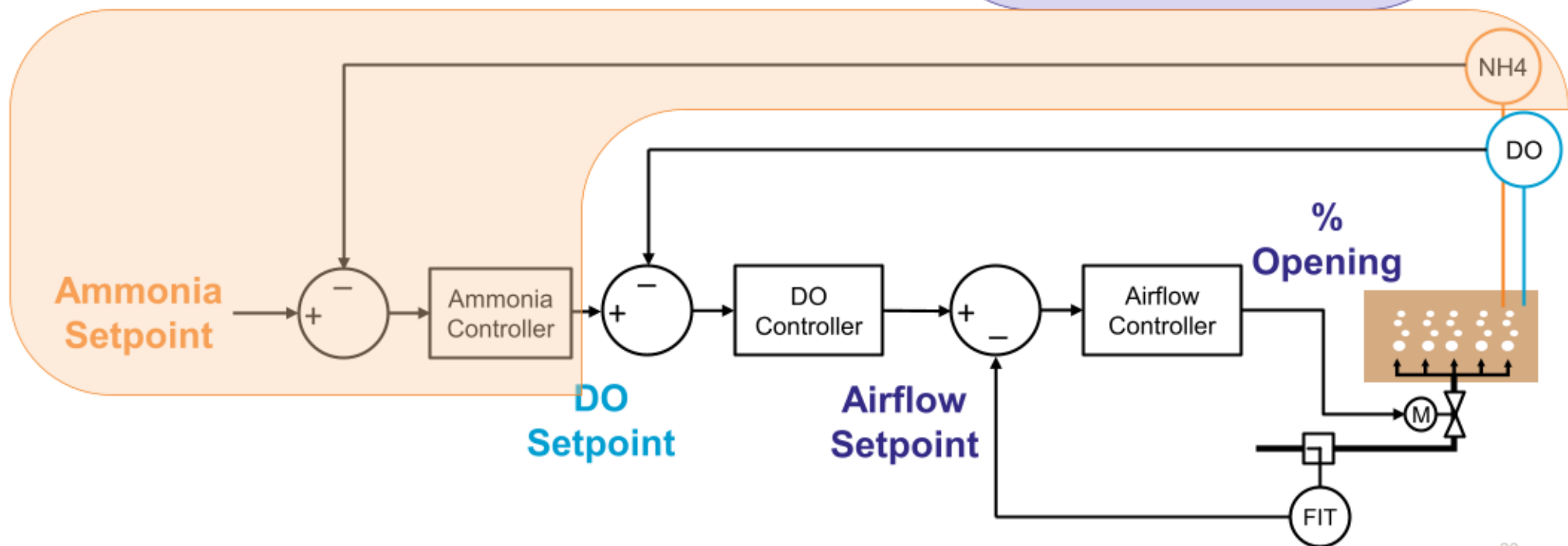

Ammonia versus NO_x-N Control

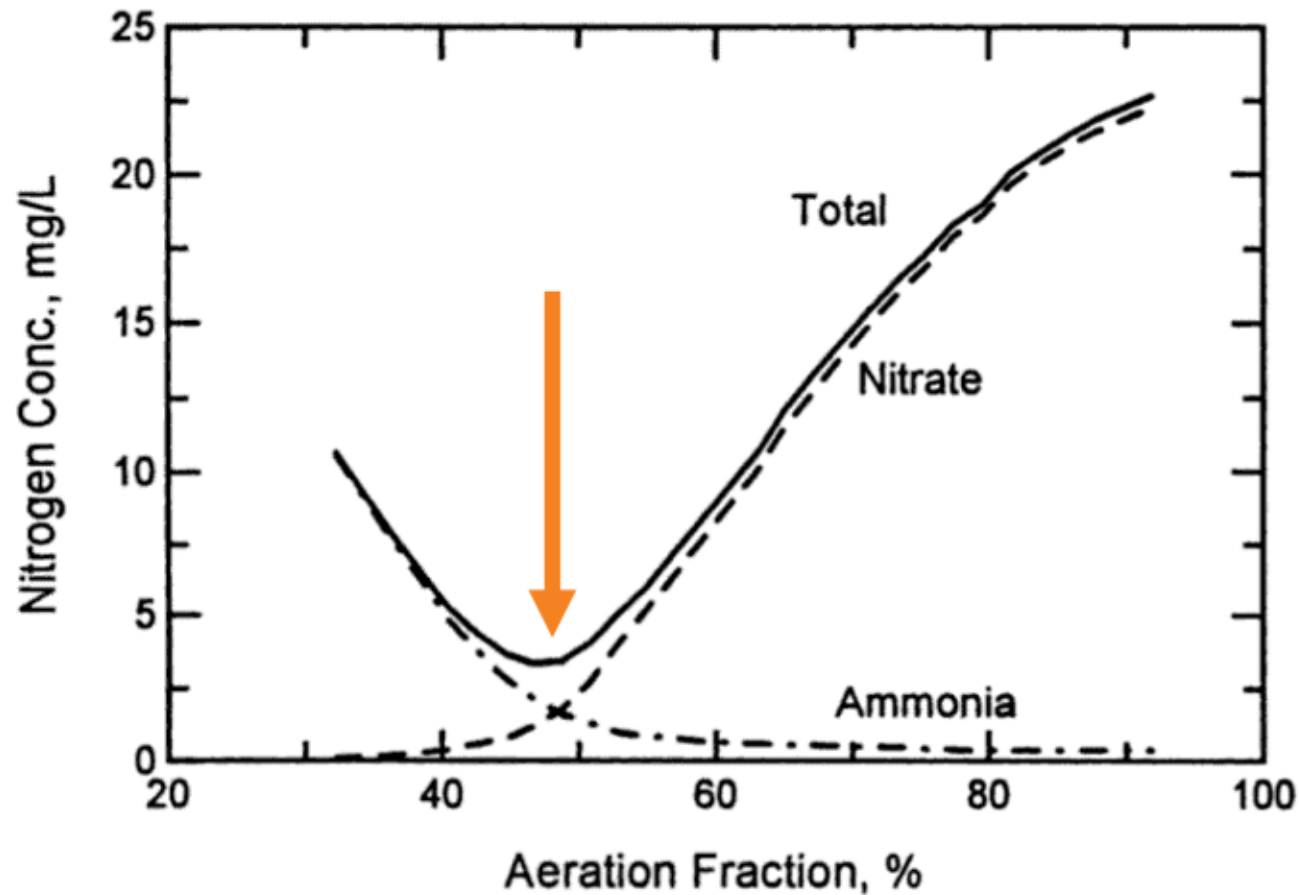

- Target effluent ammonia to NO_x-N ratio of 1 to maximize nitrogen removal
- Intermittent aeration with high DO and variable aerobic fraction (difficult to implement full-scale)
- Continuous aeration with variable DO setpoint

Batchelor, B (1983). Simulation of single-sludge nitrogen removal. *Journal of Environmental Engineering*

Low DO Case Studies



Who is Doing Low Energy BNR?

Plant	Location	Capacity (mgd)	Process	Aeration Controls	Influent BOD:N Ratio	SRT (days)	Effluent TN (mg/L)	N Removal (%)	Effluent TP (mg/L)	P Removal (%)	SVI (mL/g) ^a
Southwest	St. Petersburg, FL	20	A/O	Fixed DO	6	5	15	85	<0.5	92	150/180
Iron Bridge	Orlando, FL	25	Bardenpho	ABAC	7.1	15	1.5	-	0.5	-	115/165
Eastern Reg.	Orange Co., FL	15	Bardenpho	Fixed DO	4.1	12	2.6	89	0.6	-	120/160
Northwest Reg.	Orange Co., FL	12	Bardenpho	Fixed DO	4.5	18	2.2	91	0.5	90	130
Yankee Lake	Seminole Co., FL	5	Bardenpho	ORP	4.5	15	1.3	95	0.8	80	110
Winter Haven	Winter Haven, FL	8	Bardenpho	Fixed DO	5	25	2.4	93	Chem	-	130/190
TRA Central	Dallas TX	189	A/O	ABAC	8.2	15	<10		<0.4		60
Jame R Dilorio	Pueblo, CO	19	A ² /O with hydrocyclone	AvN	5	8-10	6	82	0.3	94	70/150
Rochester WRP	Rochester NH	5	MLE	ORP/DO	3.8	28	<8	75	NA	NA	175/290
Lynchburg WWTP	Lynchburg VA	22	Step-Feed	ABAC	10.0	8	<8	80+	<0.3	-	-/130
Borough WWTP	Stonington CT	0.7	NAS	Intermittent	5.3	-	<7	80+	NA	NA	-
Wakarusa River	Lawrance, KS	2.5	A/O	Fixed DO							
Fon-Du-Lac WRRF	Fon Du Lac, WI	10	A/O	ORP/ABAC	8.1	8-10	NA	NA	0.23	97	90/120
Full-Scale Demonstration											
Rochester WRP	Rochester MN	5	A/O with hydrocyclone	Manual ABAC	8.4	14	12 to 14	70	<0.2	95+	85/145
Seneca	WSSC, MD	25	Bardenpho	ABAC	8.5	20	2 to 3	93	0.2	97	90/130

a. Average/90th percentile SVI

Rochester, MN

A/SND with ABAC

- 2 MGD full-scale demonstration
- “Manual” ABAC with hydrocyclones

Key Findings

- “Tapered” DO profile maximized TN reduction and aeration energy reduction
- 40 to 50 percent reduction in aeration demand
- Reduced P discharges and variability which reduced alum usage by 40+ percent
- TN discharges of 12 to 14 mg/L (~65% removal)
- Carbon management critical
 - Zone 3 and 4 typically carbon limited
 - Increased RAS flow under low DO
- Minimal impacts to sludge quality

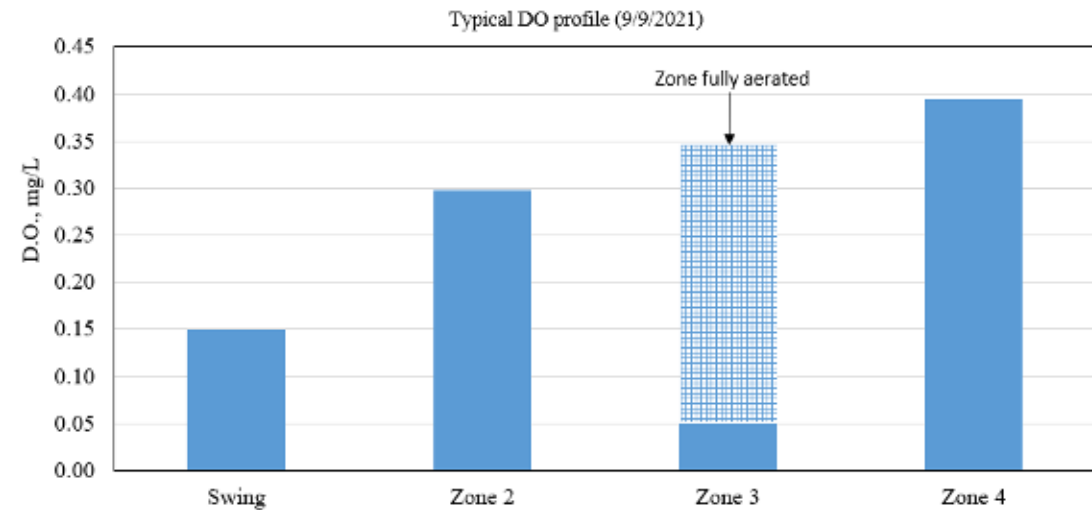
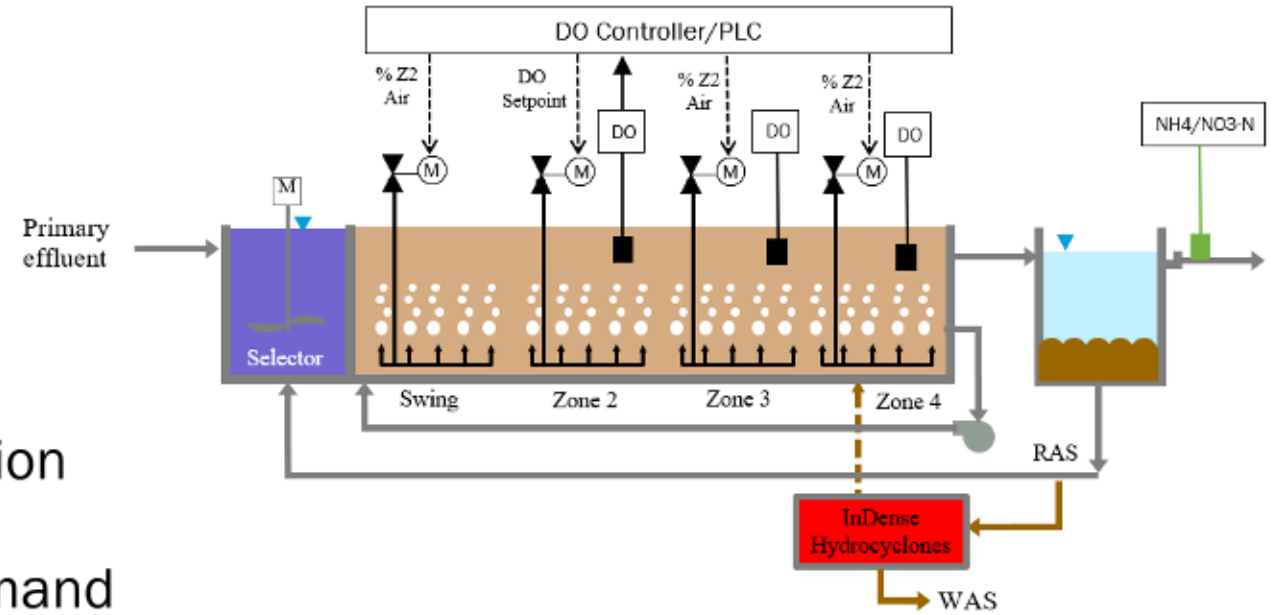

Rochester, MN

A/SND with ABAC

Full-scale design features

- One plant concept to simplify operations
- Plug flow anaerobic selector
- Step-feed to Stage 3
 - Carbon diversion to maximize TN reduction
 - Minimize wet weather final clarifier SLRs
- Swing zones for process flexibility
- Blower addition to match blower demands with aeration demands
- Diffuser layout to accommodate “normal” and low DO operations under different operating modes

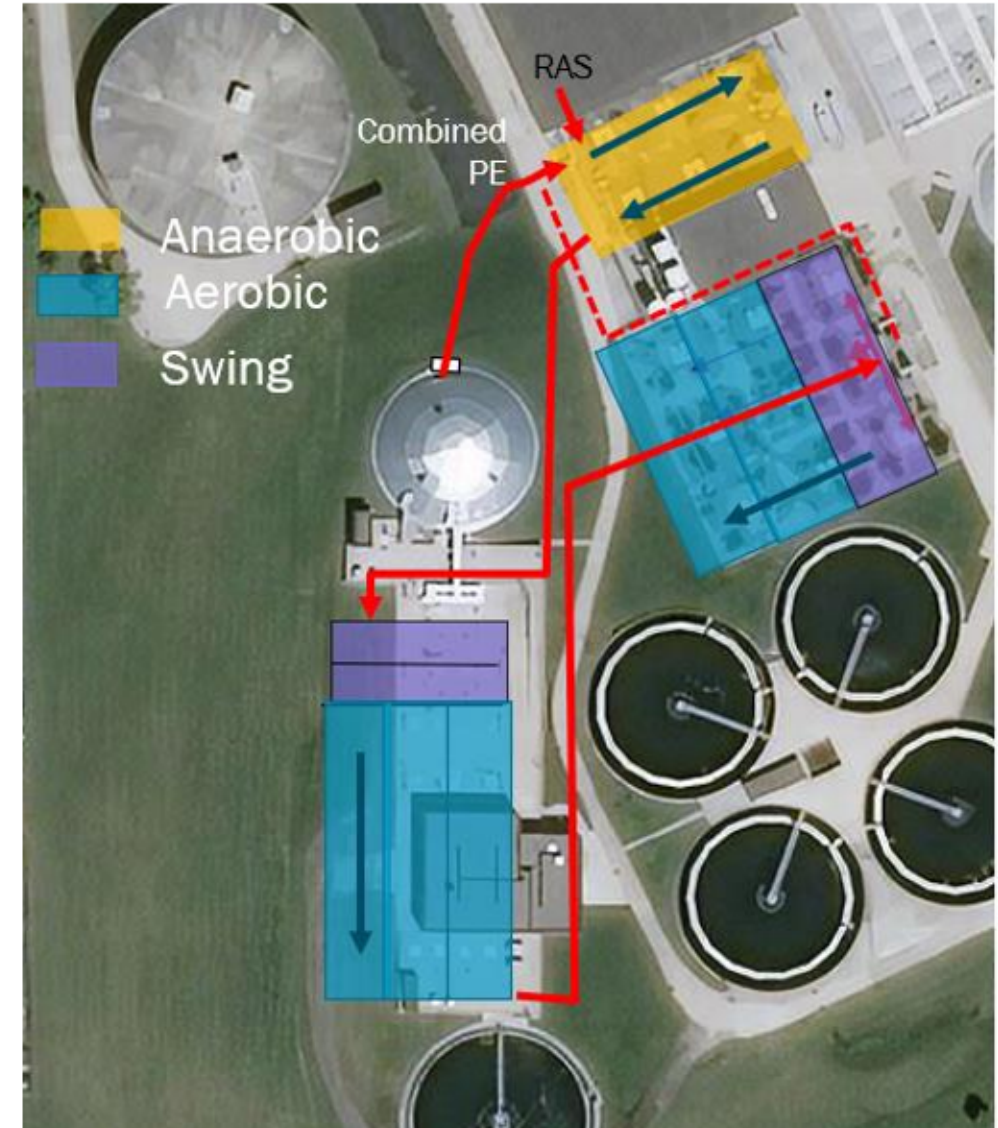

Pueblo, CO

Johannesburg A²O with AvN Control

AvN Instrumentation

- DO sensor
- 1. Ammonia Sensor
2. Nitrate+Nitrite sensor

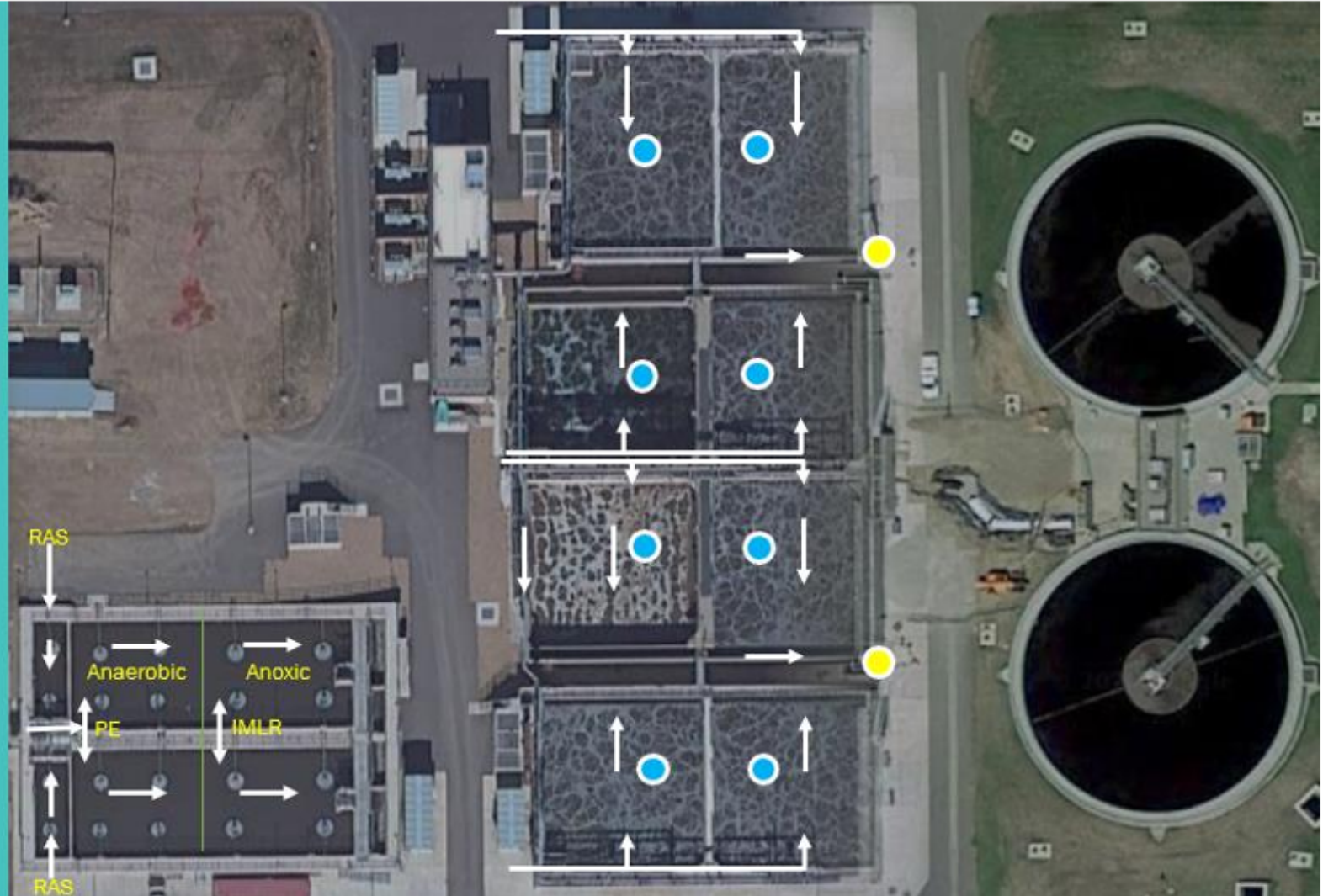

Pueblo, CO

Johannesburg A²O with AvN Control

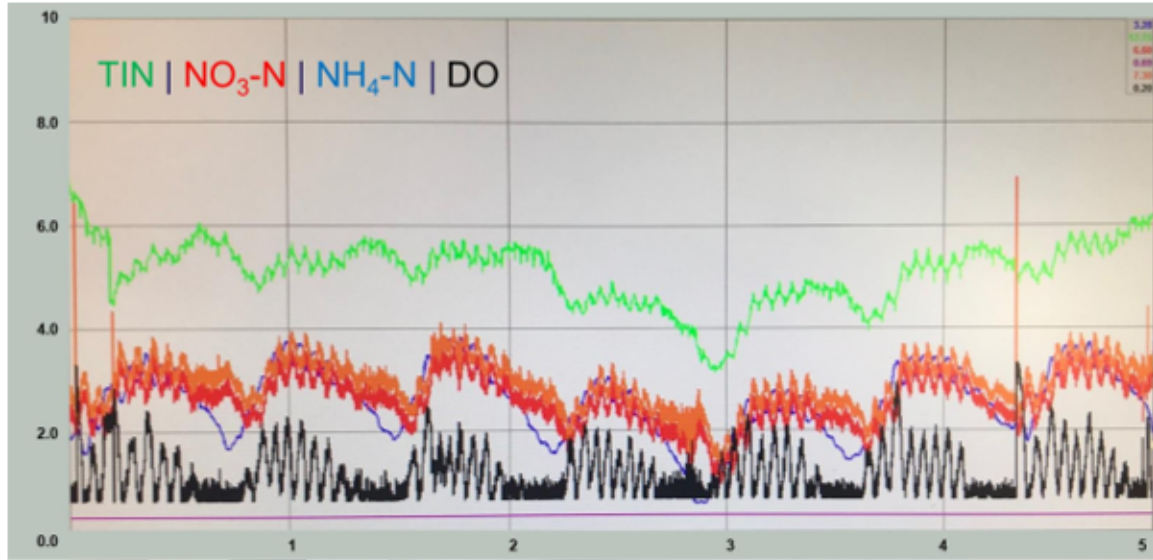

Brown and Caldwell

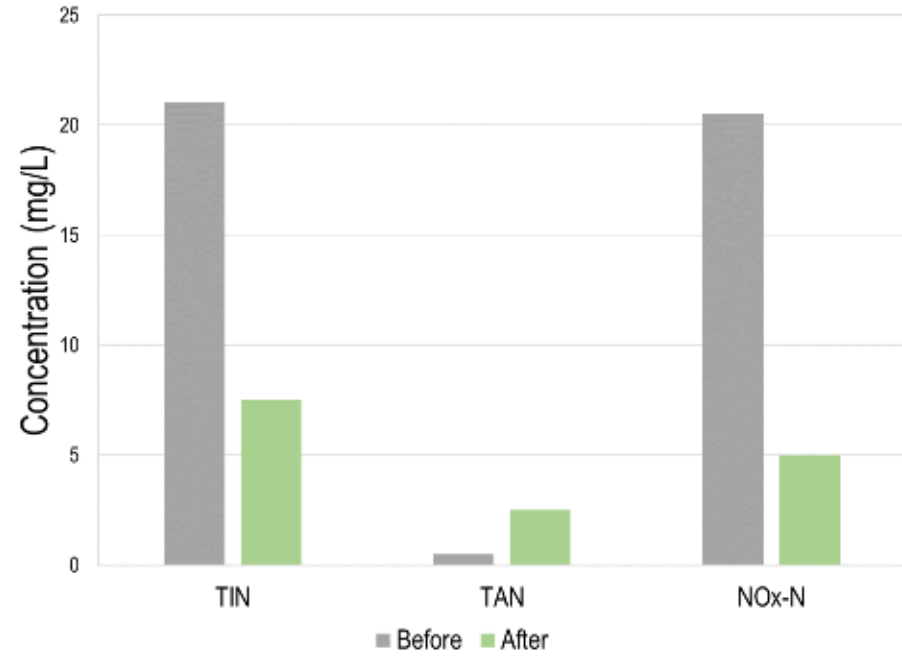

Energy Savings

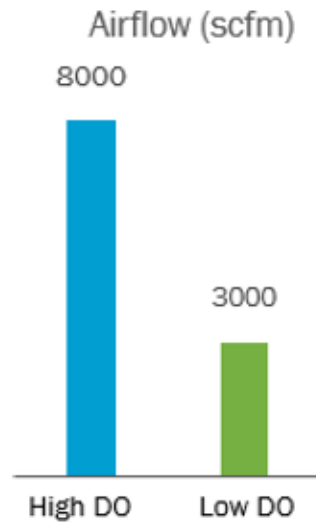

Treatment Performance

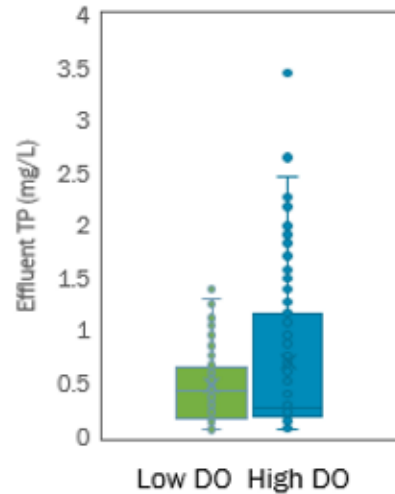

Chemical Savings

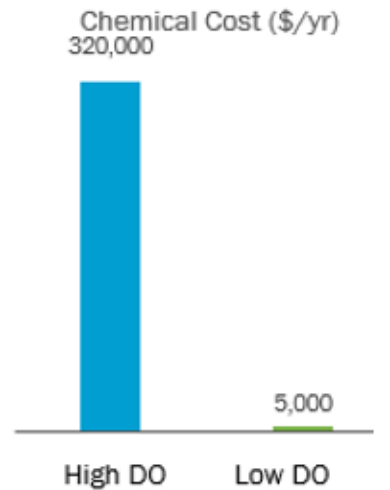

WSSC Water: Seneca WRRF

5-Stage BNR with ABAC



WSSC Water: Seneca WRRF

5-Stage BNR with ABAC

- 50th percentile DO < 0.3 mg/L
- Ammonia peaks are handled at lower DO levels

Control Train DO = 1.6 mg/L

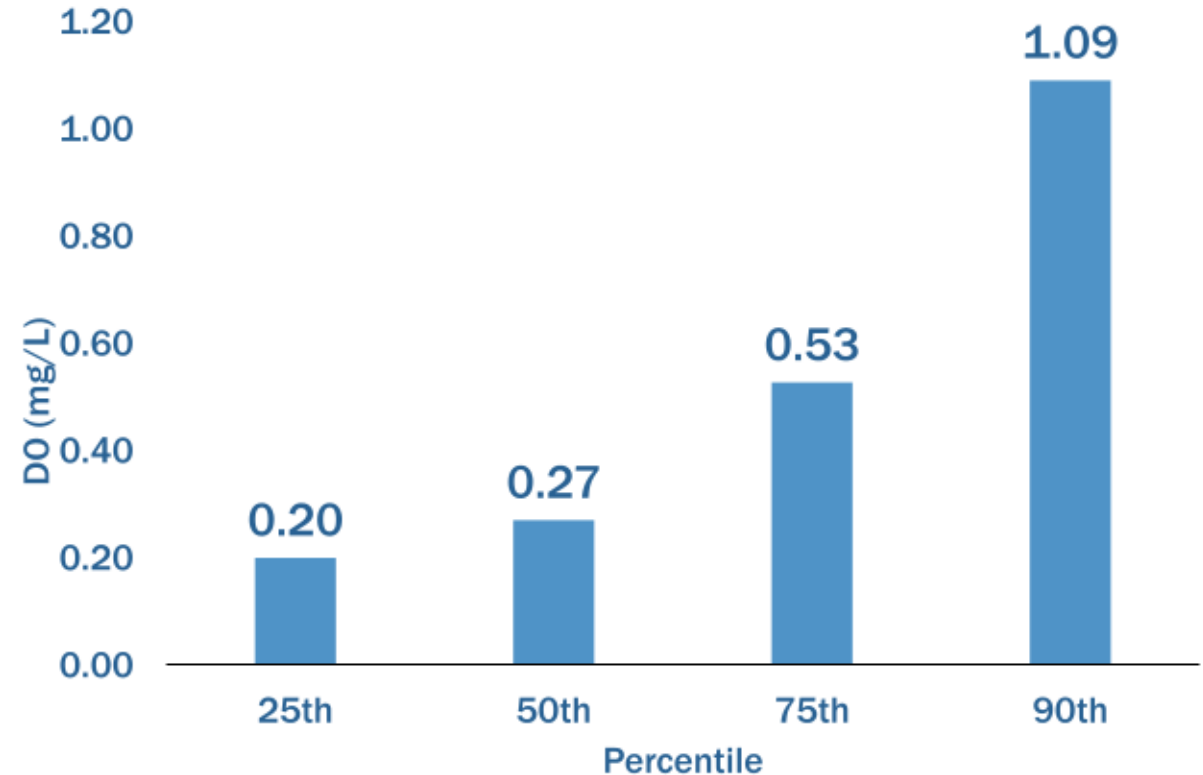

*Data collected as part of WRF Project 5071

WSSC Water: Seneca WRRF

Nitrogen Removal

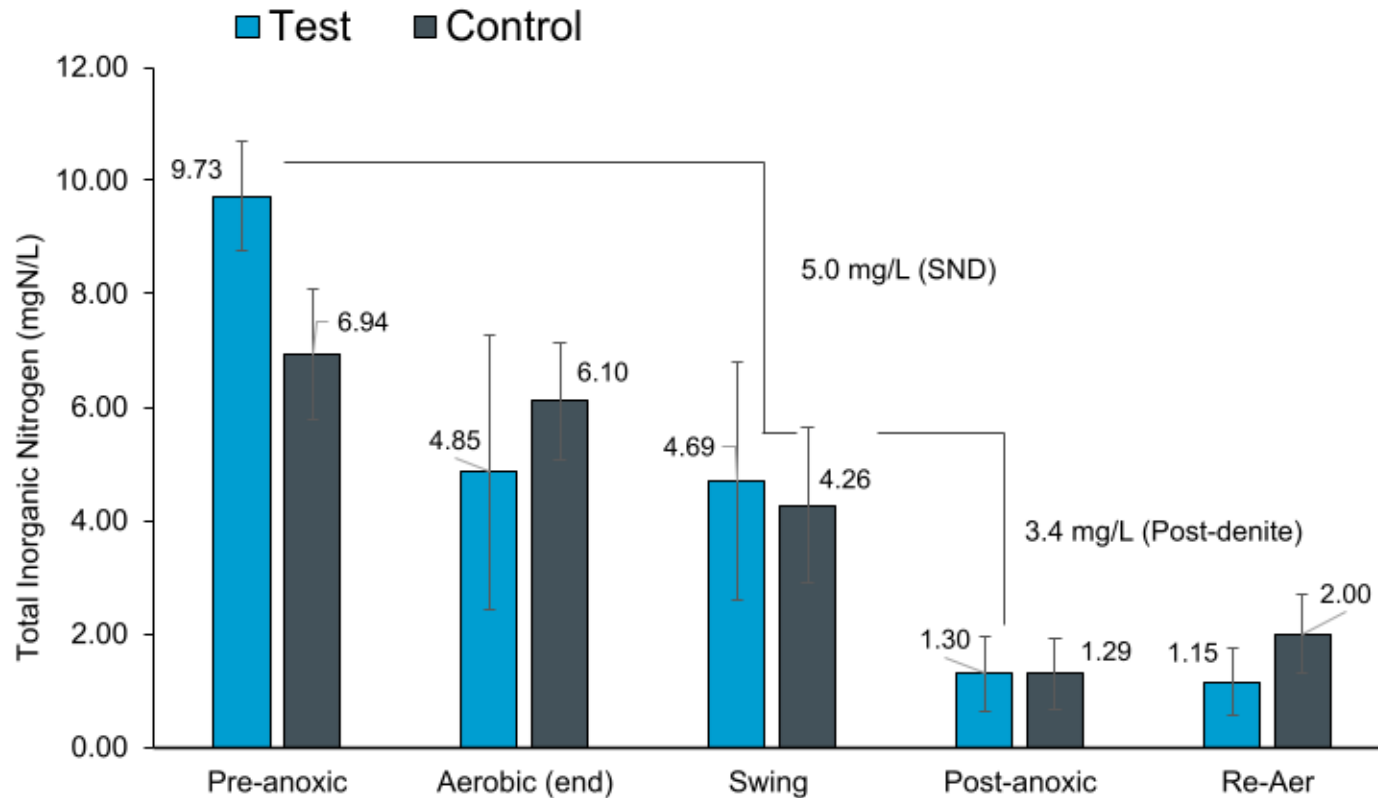

Note:

Swing zone: Test – Aerated, Control – Unaerated
Methanol added to Swing zone in Control

*Data collected as part of WRF Project 5071

TEST TRAIN OPERATED

with no methanol

~ 5 mg-N/L removed
in the aerated zone

~3.5 mg-N/L removed
in the post-anoxic zone
without addition of methanol

Glycerol may be playing a
greater role (Competibacter
GAO/Tetraspaera PAO)

SND happening
in the reaeration zone
removing ~0.7 mg-N/L

WSSC Water: Seneca WRRF

P Removal

- Pre-anoxic zone becomes anaerobic as low nitrate and DO are recycled back

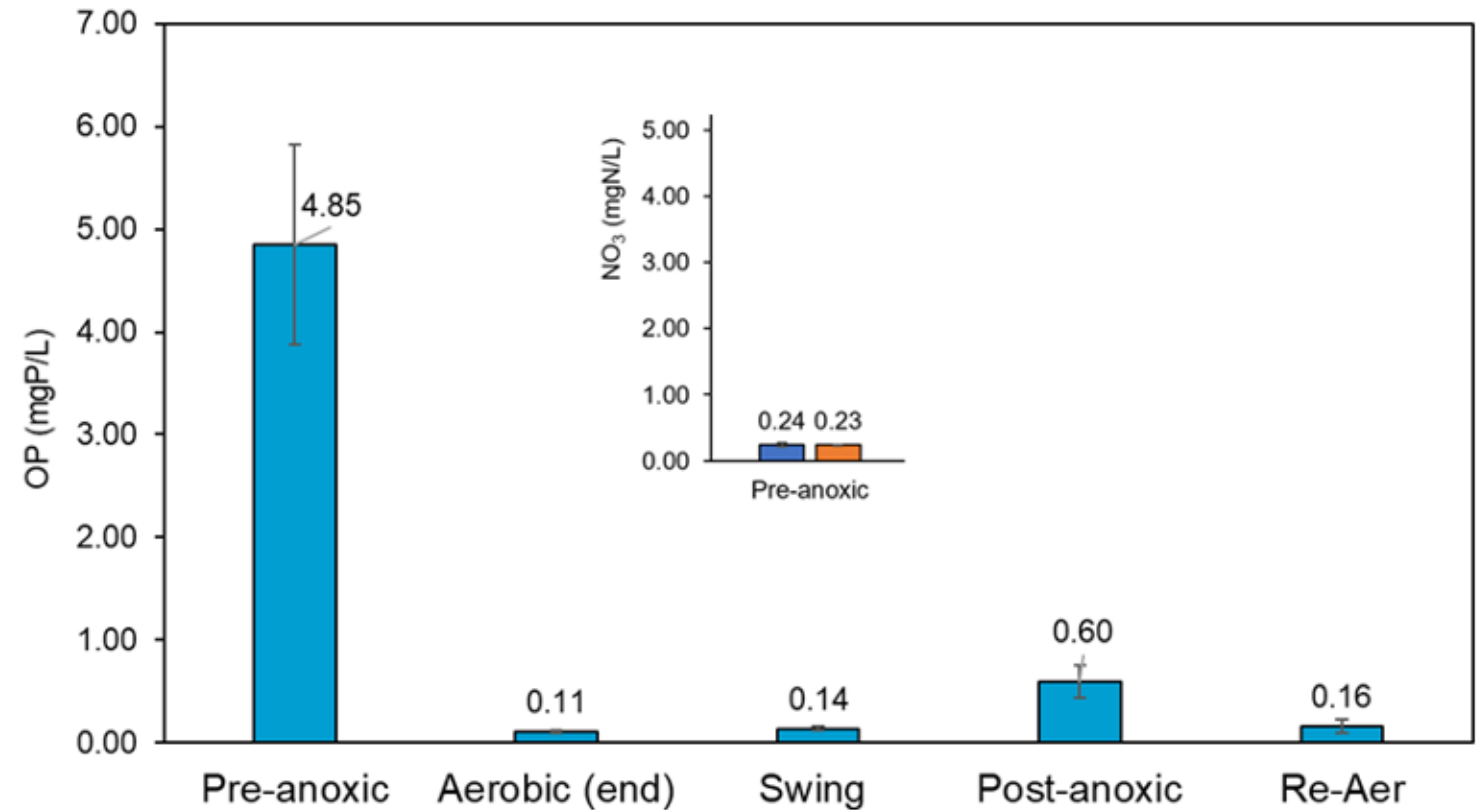

WSSC Water: Seneca WRRF

Category	Reduction	Notes	Appx. Annual Savings (\$/yr)	
Aeration Energy	35%	Average DO setpoint of 0.25 mg/L in Test train compared to 1.6 mg/L for the rest	TEST TRAIN: \$35,000	WHOLE PLANT: \$175,000
Mixed Liquor pumping	50%	Test train IMLR = 200%, Rest = 400%	TEST: \$10,000	WHOLE PLANT: \$50,000
Alum for P removal	~100%	Test train effluent Ortho-phosphate < 0.2 mg/L	TEST: \$50,000	WHOLE PLANT: \$250,000
Methanol for N removal	100%	No methanol added to test train, TIN < 2.5 mg/L (225 gal/d on average for the whole plant)	TEST: \$20,000	WHOLE PLANT: \$100,000
TOTAL SAVINGS			TEST: \$105,000	WHOLE PLANT: \$575,000

Note: Savings are projected based on current performance

*Data collected as part of WRF Project 5071

WSSC Water: Seneca WRRF

Full-scale whole plant results (three months of operation)

- TN \sim 2 mg/L – 50th percentile, 2.7 - 90th percentile (without supplemental carbon)
- TP < 0.2 mg/L (with periods of no alum, on track to eliminate)
- Aeration savings \sim 40%
- SVI < 100 mL/g

Yankee Lake WRRF

4-Stage BNR with ORP Control

- 2.25 MGD “4-Stage” BNR
- Effluent TIN <1 mg/L on consistent basis
- Industry challenge:
 - What are the underlying factors driving nutrient removal performance?
 - Can we translate findings from Yankee Lake to other facilities?

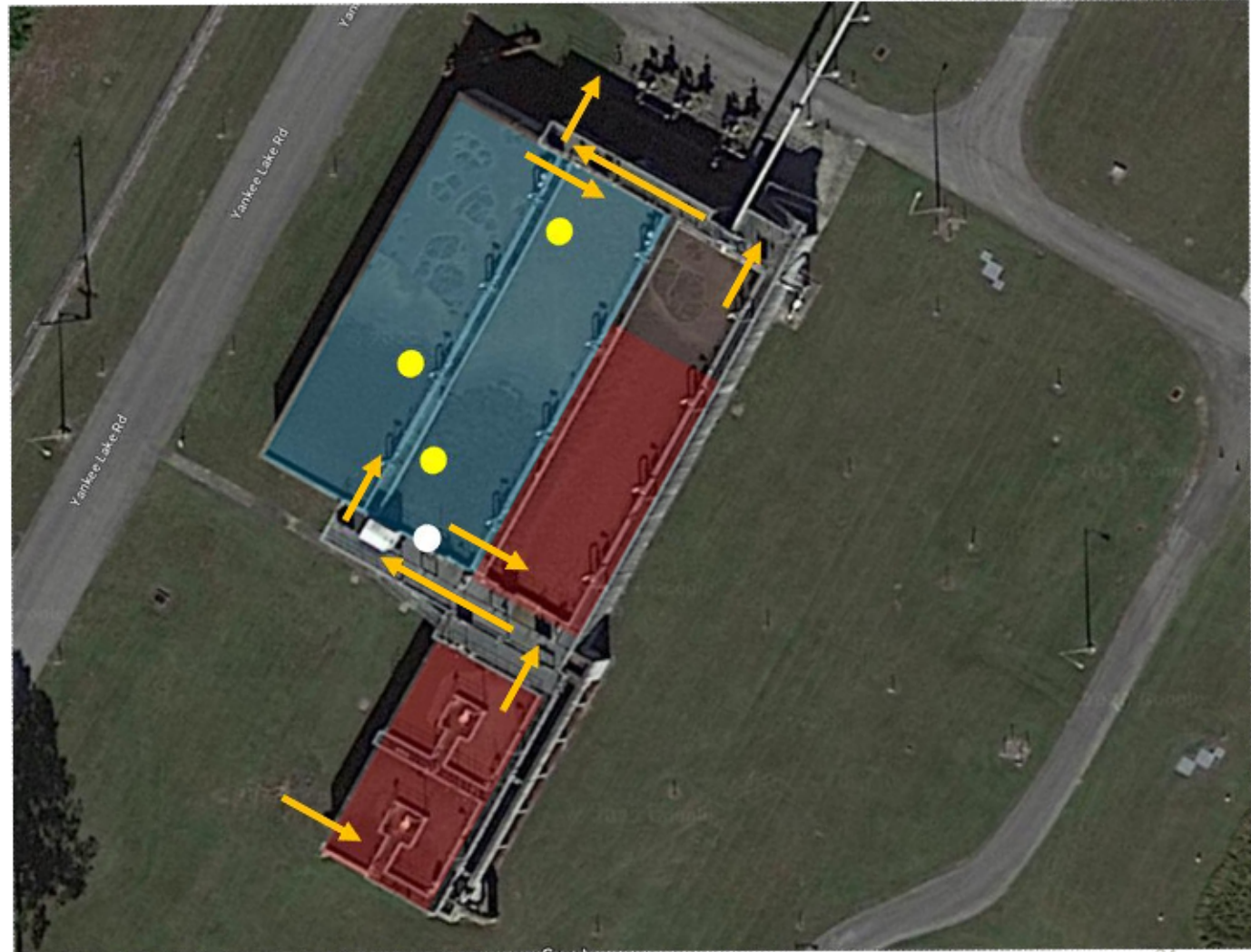

Yankee Lake WRRF

4-Stage BNR with ORP

- ORP control only
 - Maintain 50 mV or less in aerated zones
- ORP suggests it is operating as 5-stage BNR

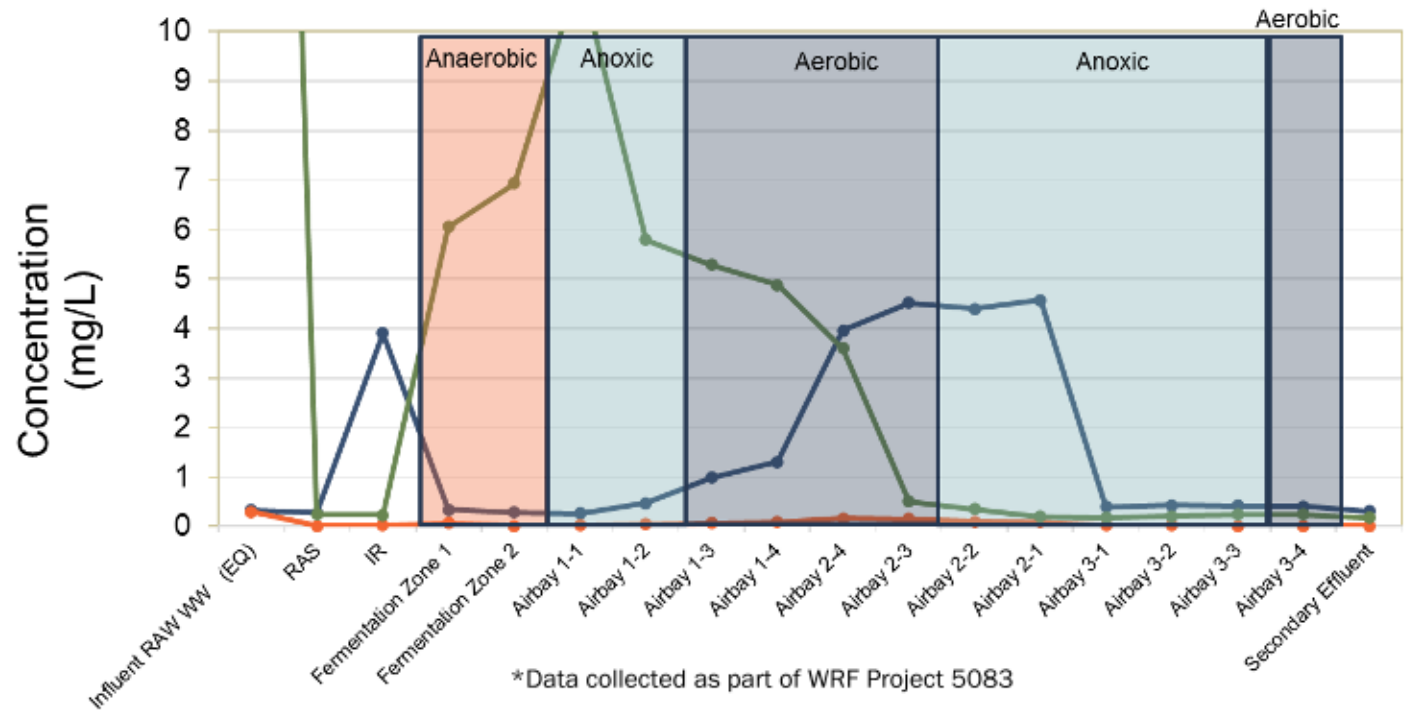
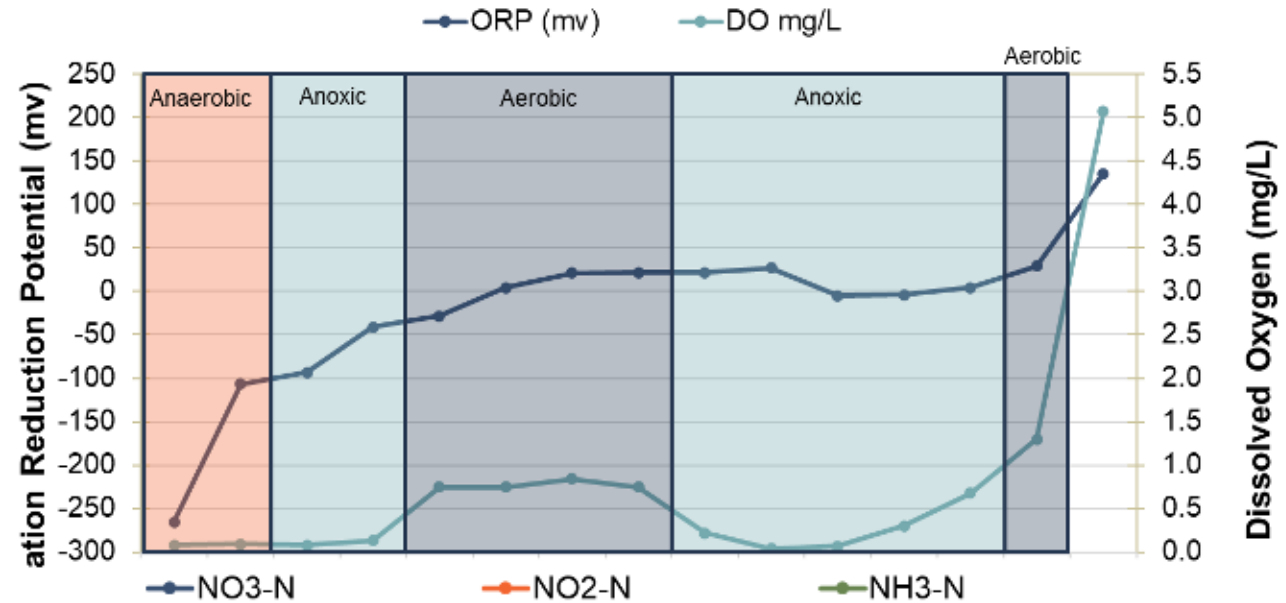

Yankee Lake WRRF

4-Stage BNR with ORP

- TP < 1 mg/L
- TIN < 1 mg/L

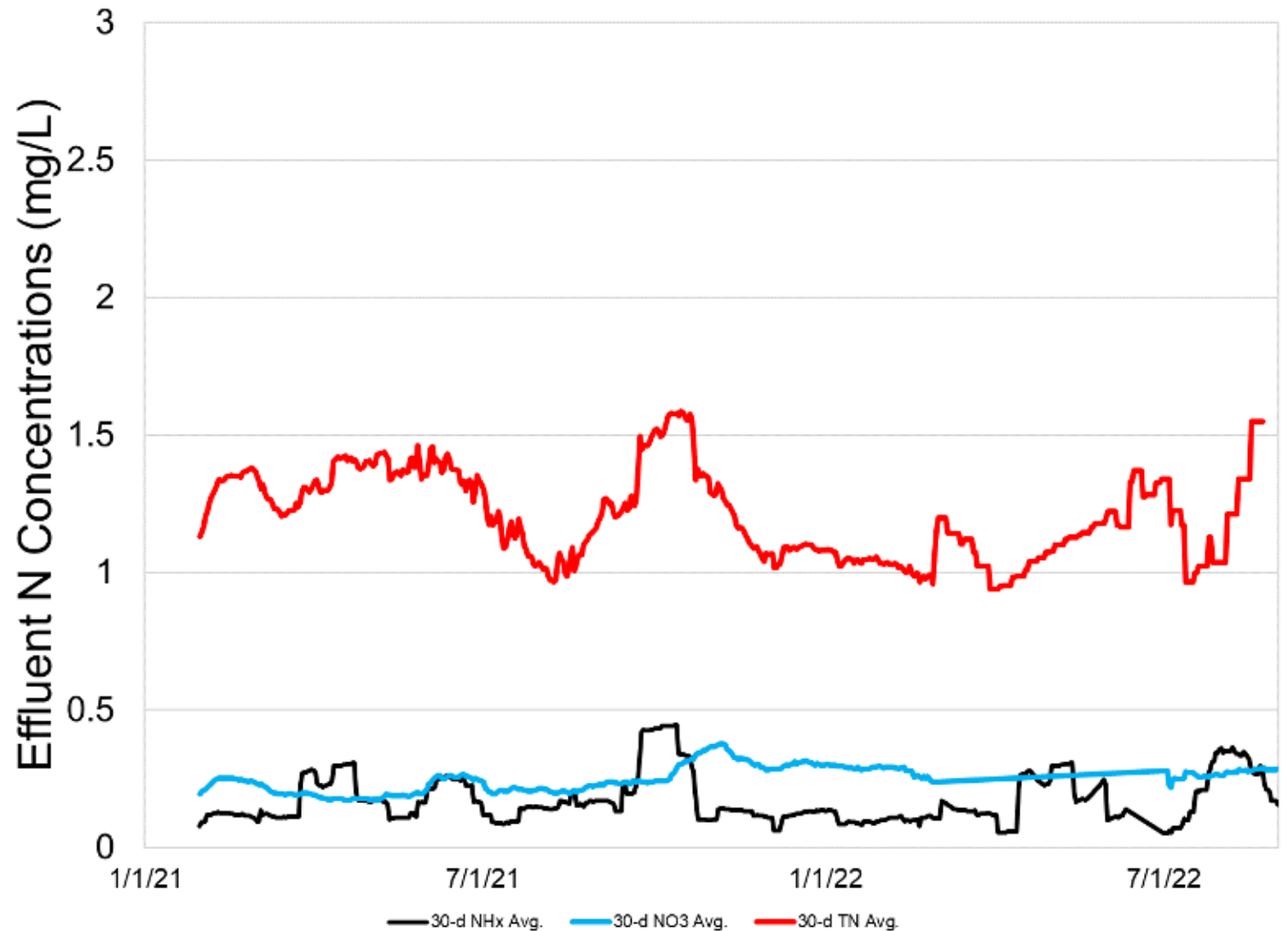

Summary

- Low DO nitrification rates are approximately 80% of maximum rates
- Maximum rates not affected by low DO operation
- Nitrifiers can have high DO affinity and the apparent K_{DO} decreases as DO decreases
 - Need to design for aeration system turndown
- AOA and CMX appear to be the predominant nitrifiers in low DO systems
- SND occurs between 0.2 to 0.7 mg/L
 - Substrate dependent
- Low DO seems to improve Bio-P
- Reduced energy and chemical costs



Thank you.

Questions?

Brown AND **Caldwell** :



WRF No. 5083 - Advancing Low Energy Biological Nitrogen and Phosphorus Removal



Acknowledgements – WRF 5083

- Stephanie Fevig (PM), Water Research Foundation
- Jose Jimenez (PI), Brown and Caldwell
- Belinda Sturm (Co-PI), University of Kansas
- Leon Downing (Co-PI), Black & Veatch
- Charles Bott (UAC), Hampton Roads Sanitation District
- Peter Dold (QC), EnviroSim
- Daniel Noguera (QC), University of Wisconsin-Madison
- Charlotte Water, North Carolina
- City of Rochester, Minnesota
- City of Boise, Idaho
- Washington Suburban Sanitation Commission, Maryland
- City of Lawrence, Kansas
- Madison Metropolitan Sewage District, Wisconsin
- Hampton Roads Sanitation District, Virginia
- King County, Washington
- Trinity River Authority, Texas
- City of Pueblo, Colorado
- City of St. Petersburg, Florida