



# **Metropolitan Water Reclamation District of Greater Chicago**

**Welcome to the February  
Edition of the 2023 M&R  
Seminar Series**

## NOTES FOR SEMINAR ATTENDEES

- Remote attendees' audio lines have been muted to minimize background noise.
- A question and answer session will follow the presentation.
- For remote attendees, Please use the "**Chat**" feature to ask a question via text to "Host."
- The presentation slides will be posted on the MWRD website after the seminar.
- This seminar has been approved by the ISPE for one PDH and pending approval by the IEPA for one TCH. Certificates will only be issued to participants who attend the entire presentation.

# **Dr. Bernhard Wett**

## Chief Executive Officer ARAconsult



Dr. Bernhard Wett is Chief Executive Officer of ARAconsult, with consultancy projects in over 50 countries. His civil engineering background includes research and lecturing appointments at the University of Innsbruck, Austria. Dr. Wett's research focus is on high-strength ammonia wastewater, anaerobic digestion and energy optimization. He has contributed to developing, standardizing and distributing process intensification technologies like inDENSE, DEMON, TripleA and Biocos. He is working with Dynamita on the development of the Simulator SUMO in order to model mass- and energy-balances of these innovative technologies.

# Converting Rectangular and Circular Primary Tanks into the AAA Biologically Enhanced Clarification Settler

Bernhard Wett, Peter Aichinger and Sudhir Murthy

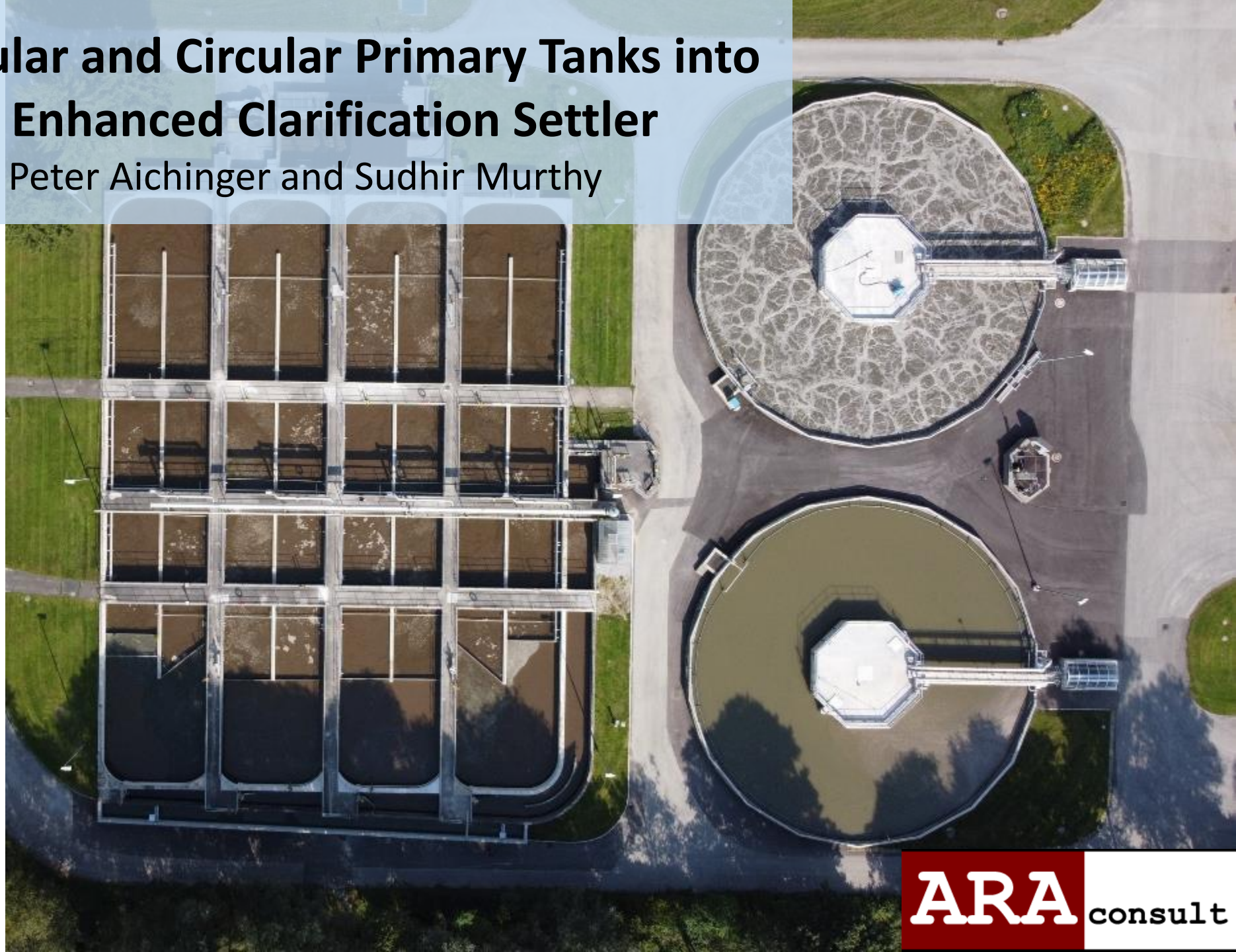



# Intro: bio-sorption approach

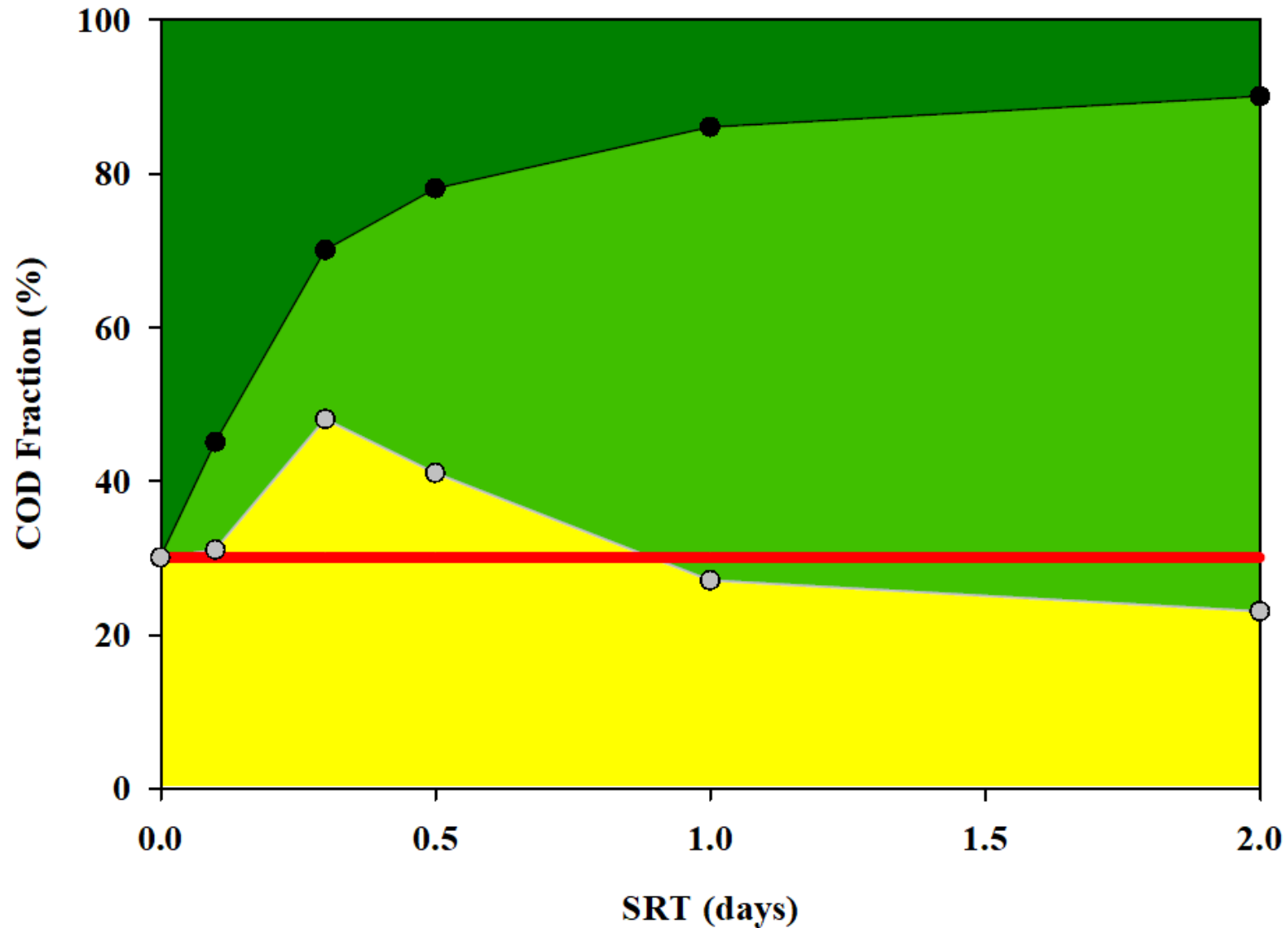

(—) represents assumed 30% COD removal by primary sedimentation; ■ effluent COD;  
■ COD oxidized; ■ COD captured as WAS.

Figure provided by M. Miller and data adopted from Jimenez et al. (2015).

# Alternating Activated Adsorption

Alternating feed/withdraw-cycle (const. water-level) spans half the time and a waste/react/settle cycle that spans the other half

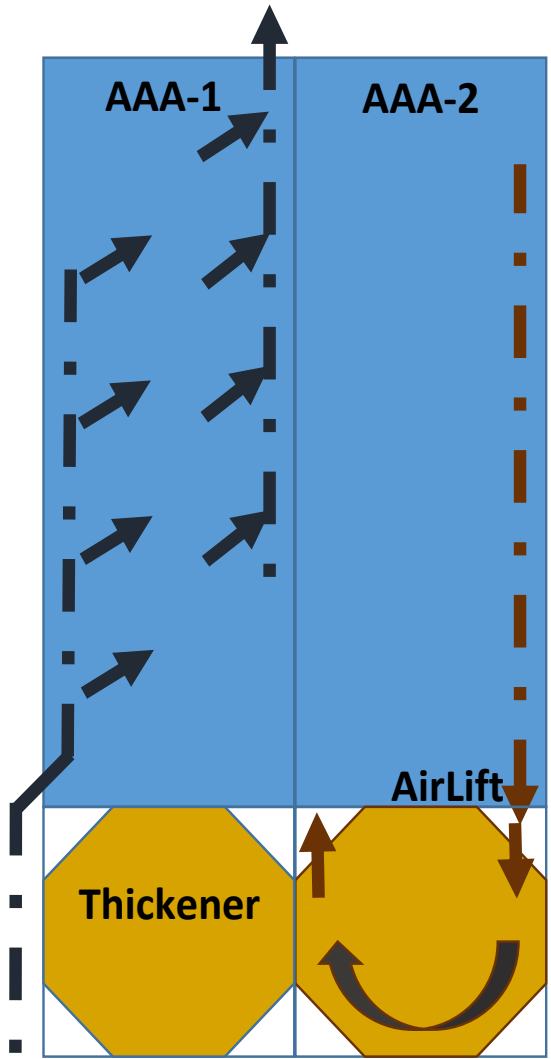

Feed/withdraw in AAA-1 while waste/react/settle in AAA-2

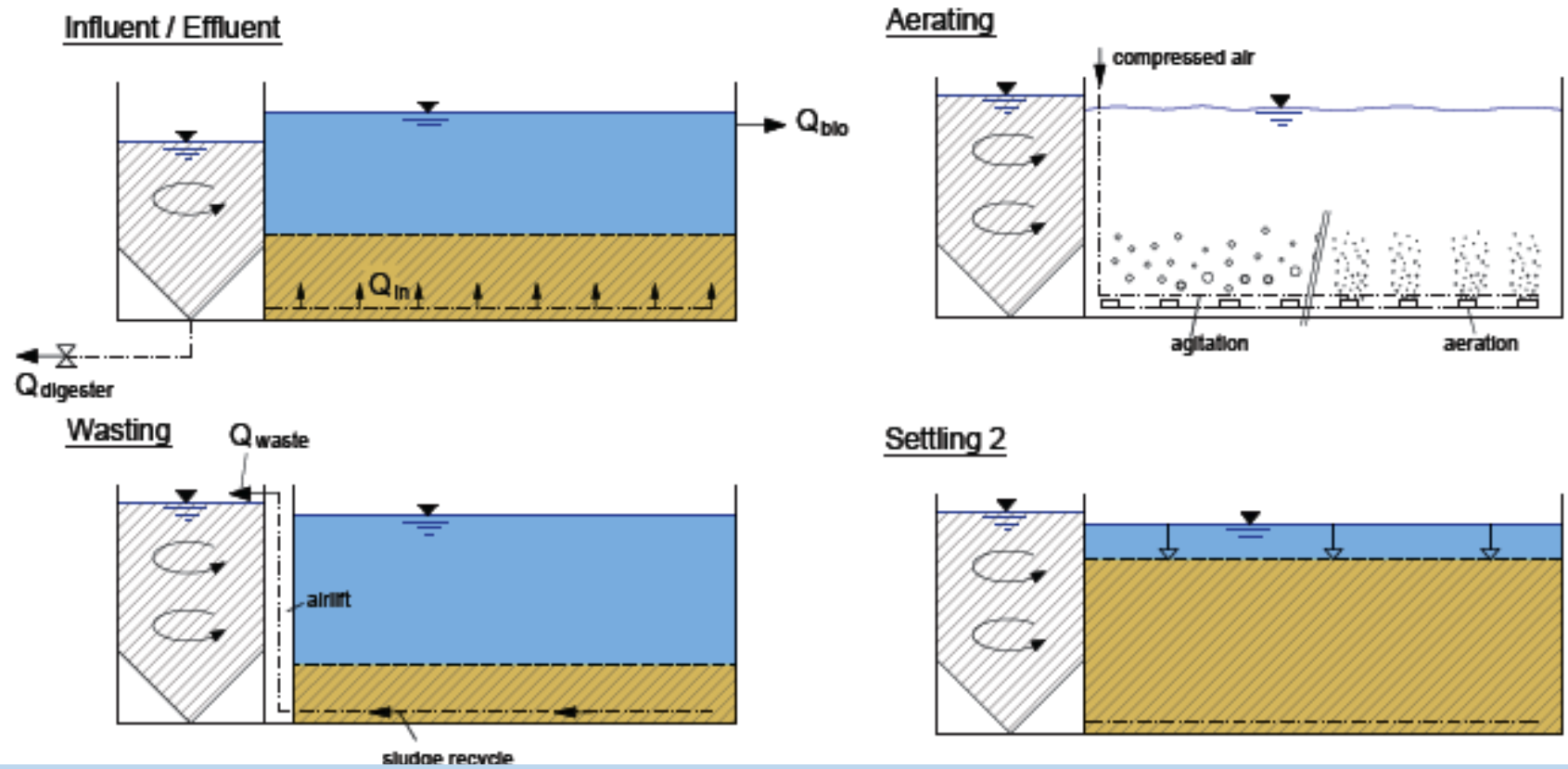
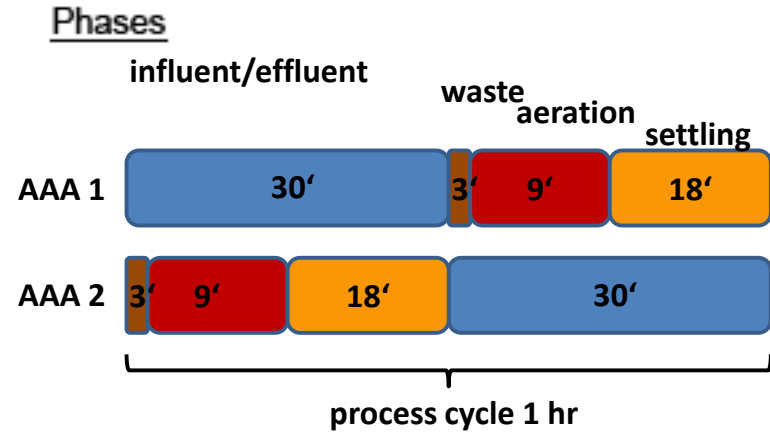

Schematic cross-section of one AAA-lane showing all process phases of an operation cycle – Air-driven without mechanical equipment like pumps, scrapers or mixers



# Conversion of rectangular PT: WWTP Alta Badia



Retrofit of the sludge-hopper-zone into AAA-thickener

# Conversion of rectangular PT: WWTP Alta Badia



# Conversion of rectangular PT: WWTP Alta Badia



>50% capacity-increase (60000 PE)

■ 2019 ▲ 2017 --- Linear (2019) - - - Linear (2017)

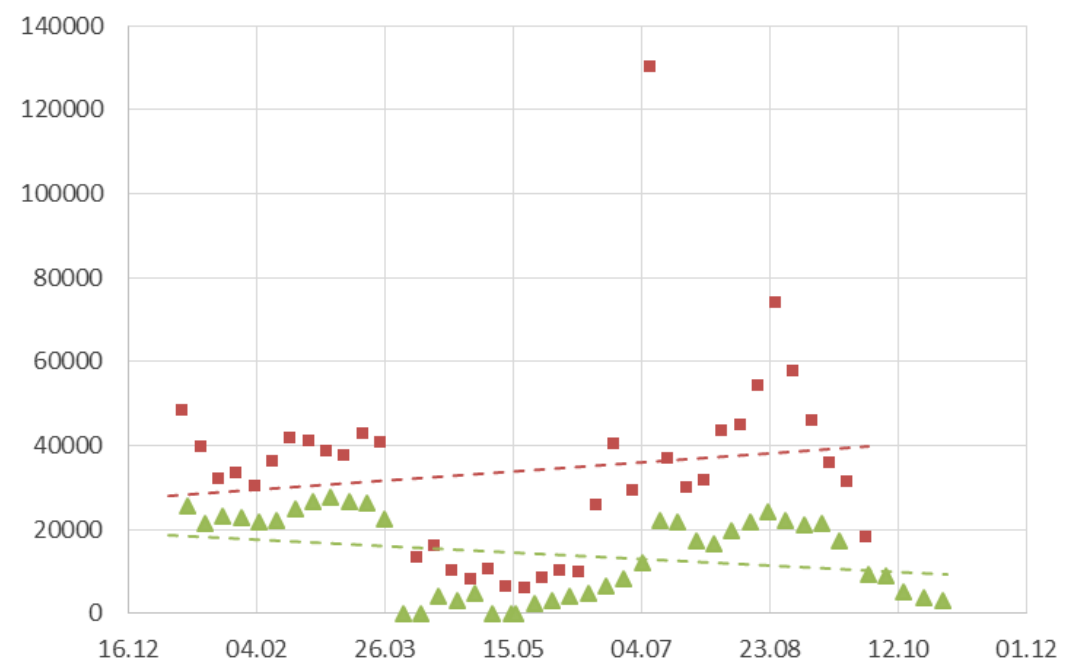

# Conversion of rectangular PT: WWTP Alta Badia



N-elimination in downstream B-stage.  
Step-feed to unaerated zones as C-source

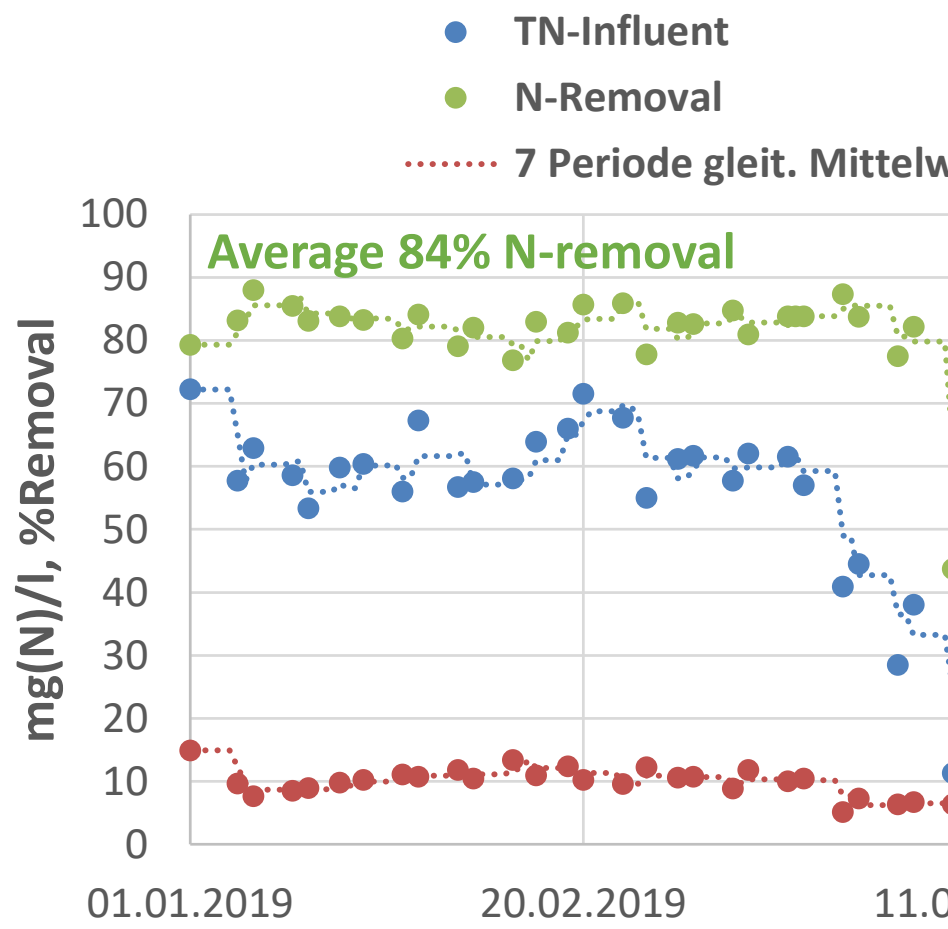

# Conversion of rectangular PT: WWTP Alta Badia

## inDENSE - SVI-improvement for

- high biomass concentration (6-7 gMLSS/L) in B-stage
- co-thickening of A- and B-stage in AAA

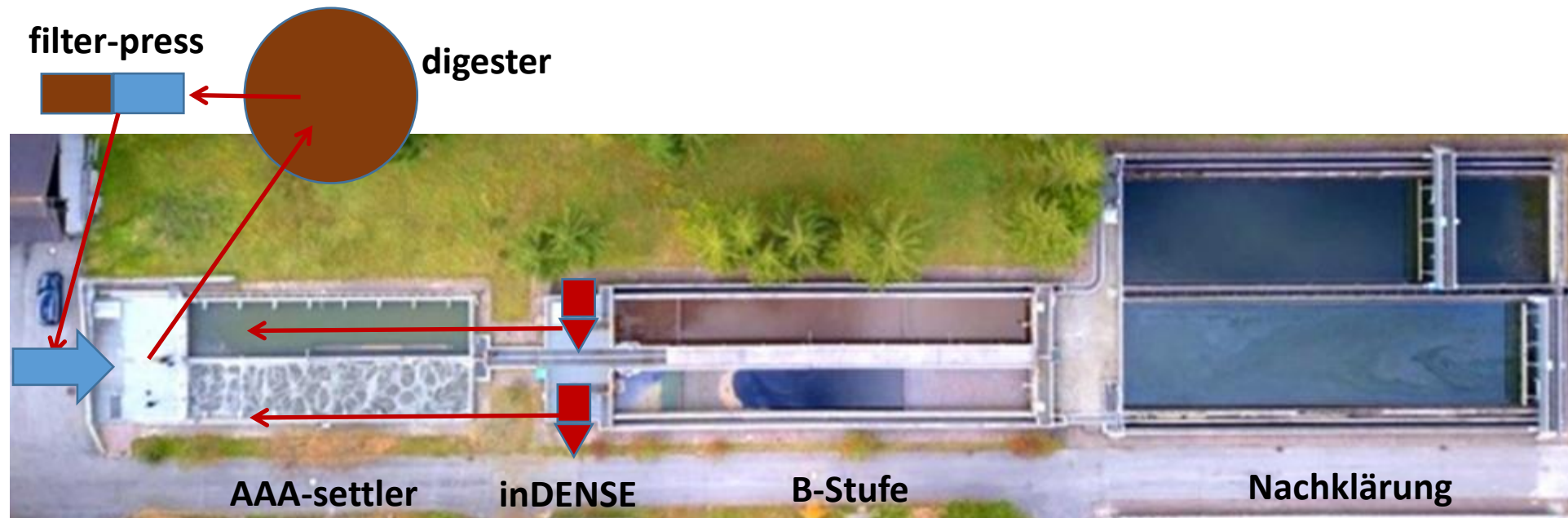

# Conversion of square-tanks: WWTP Zirl, 17 MLD

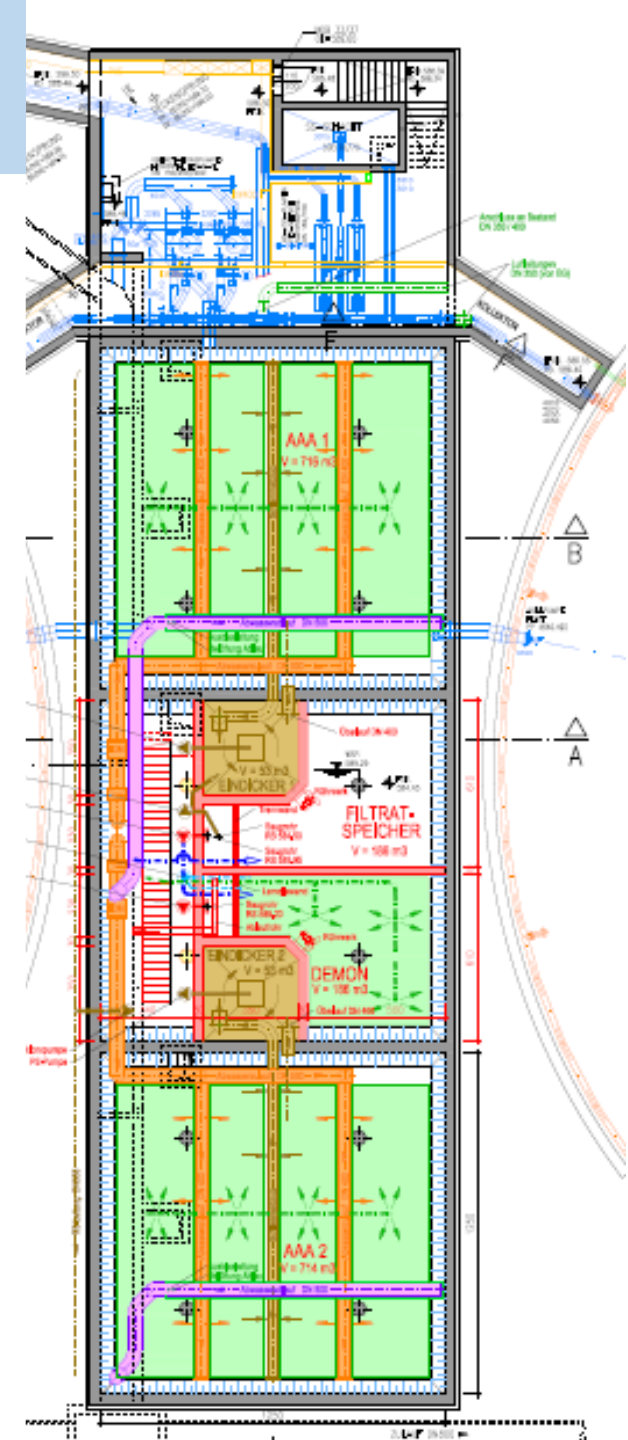

# Energy balance: WWTP Zirl, 17 MLD

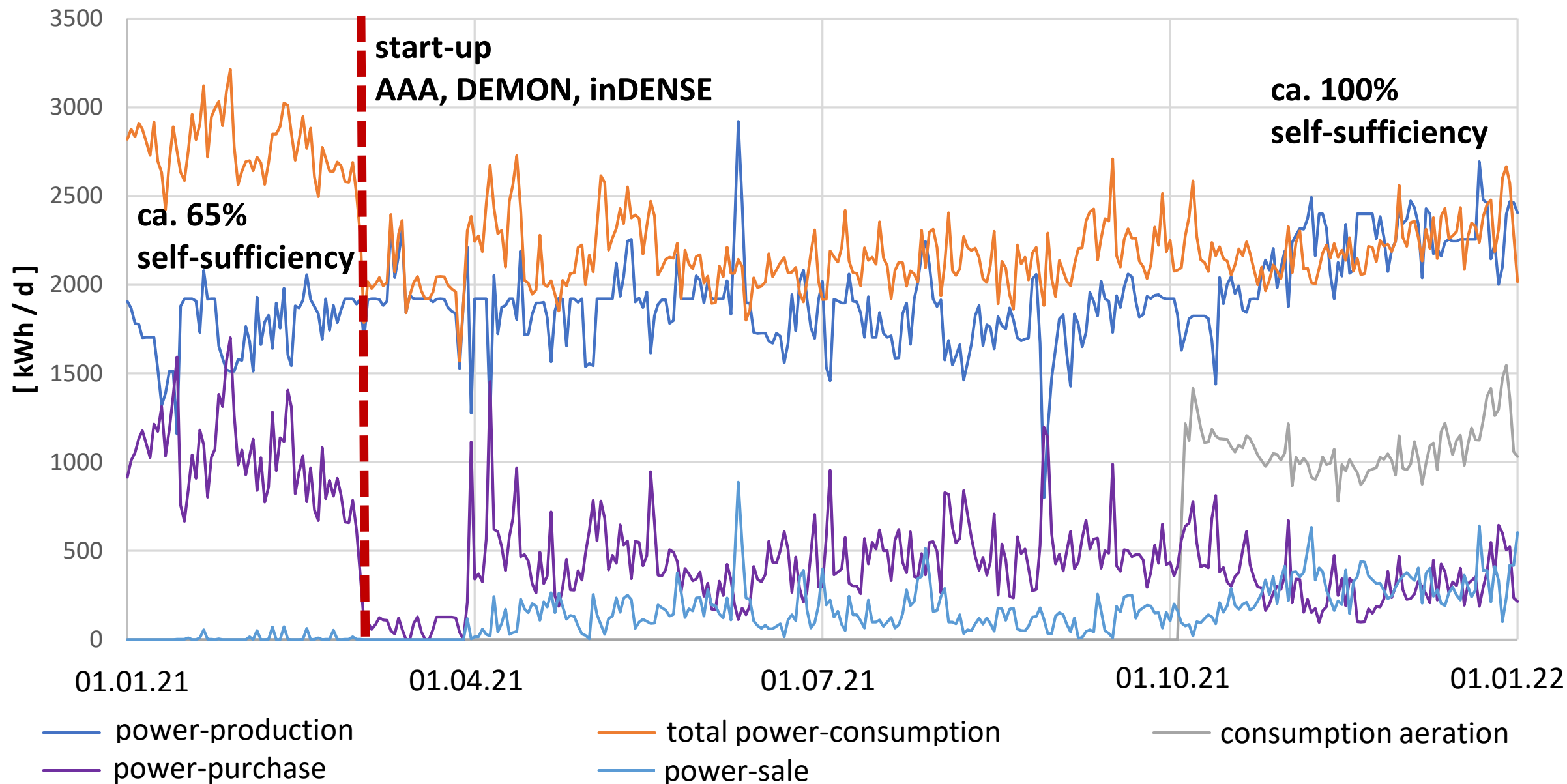

# Construction of rectangular AAA-tanks: WWTP Villach, 27 MLD

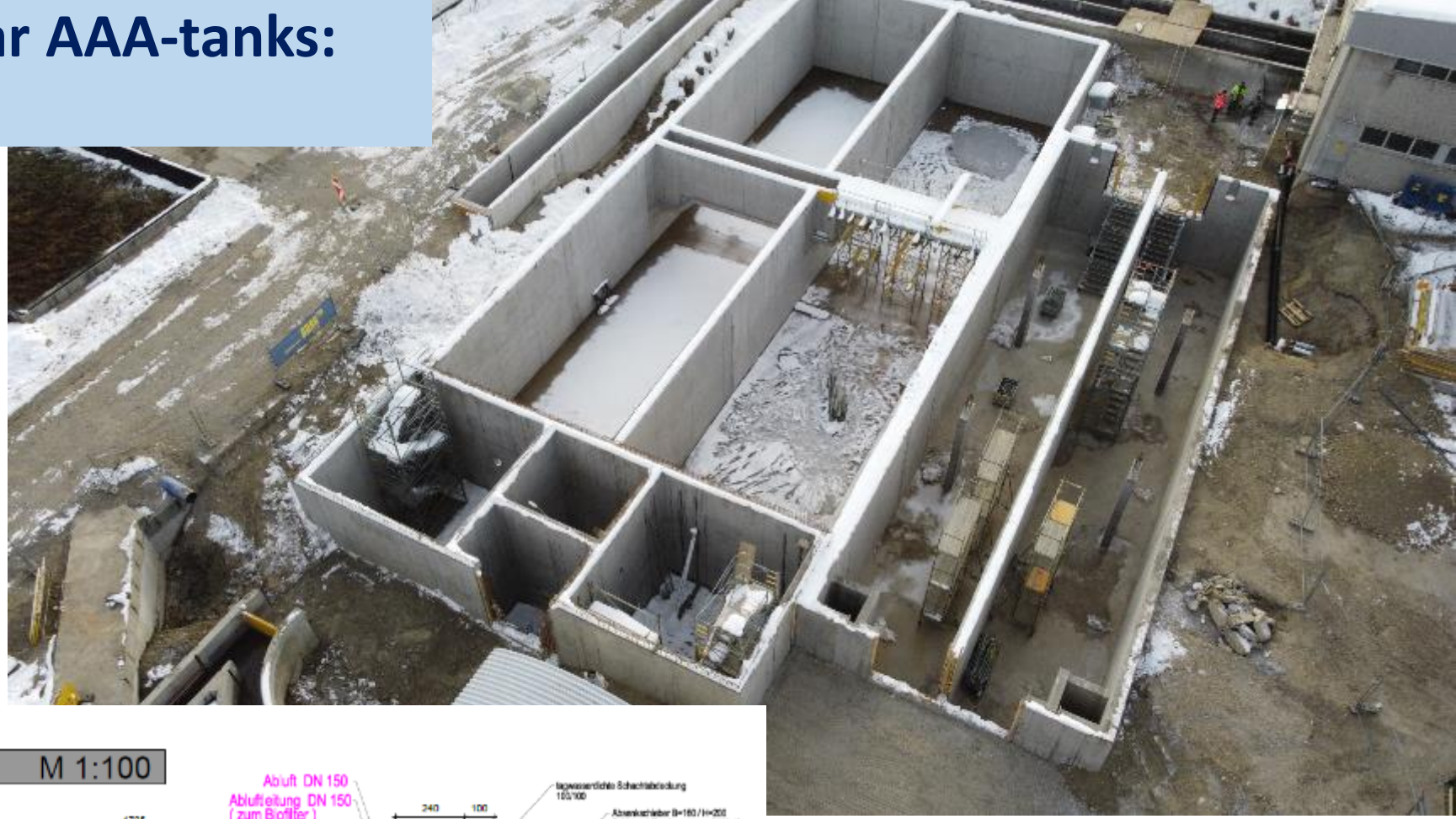

**SCHNITT B - B M 1:100**

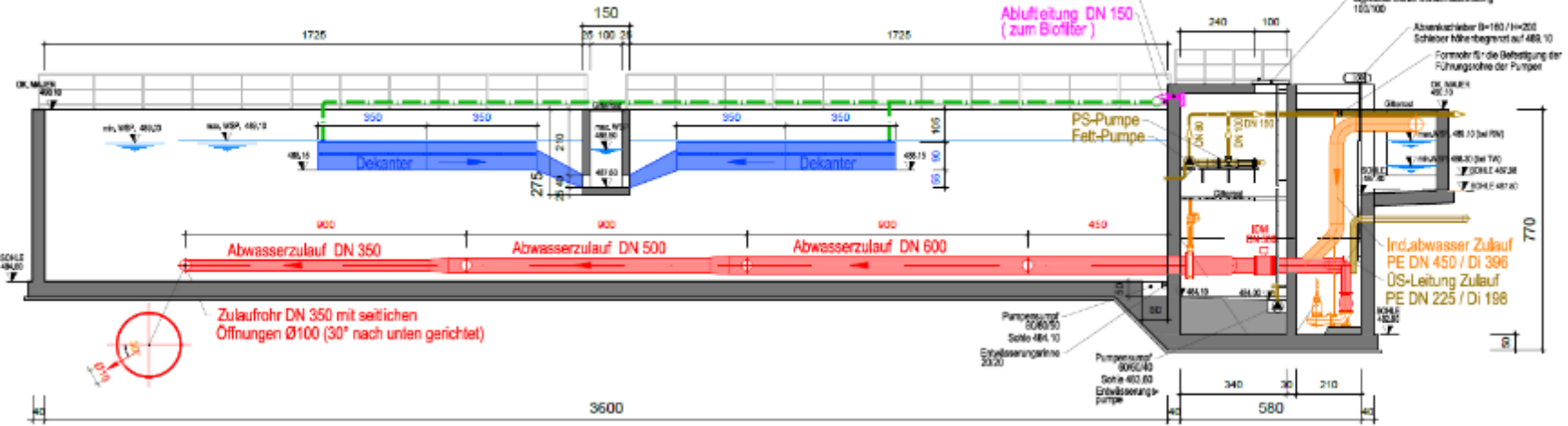



# WWTP Villach, 27 MLD

## Nitrate removal from semiconductor industry

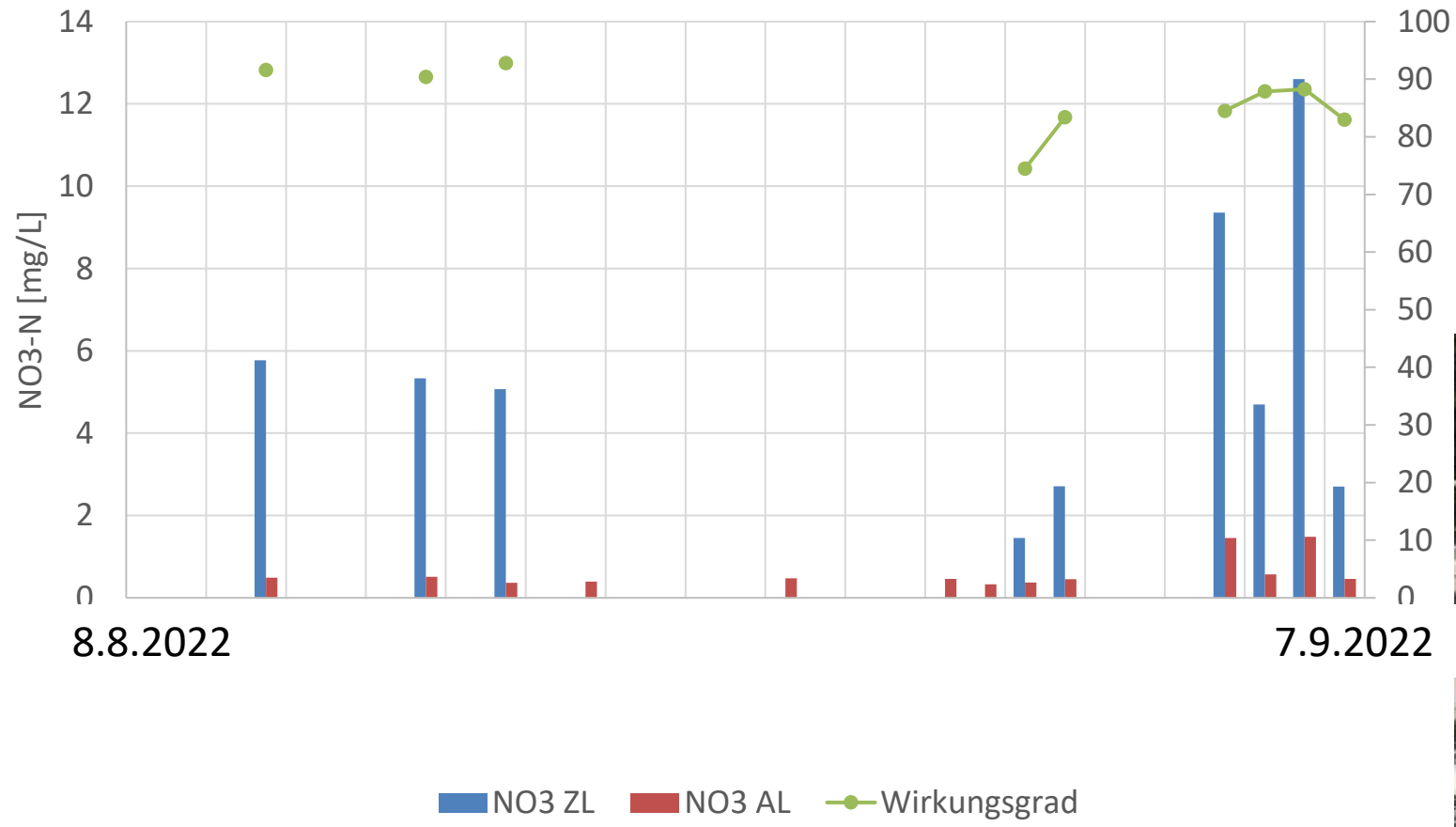

## SCHNITT ZULAUFLEITUNG M 1:200

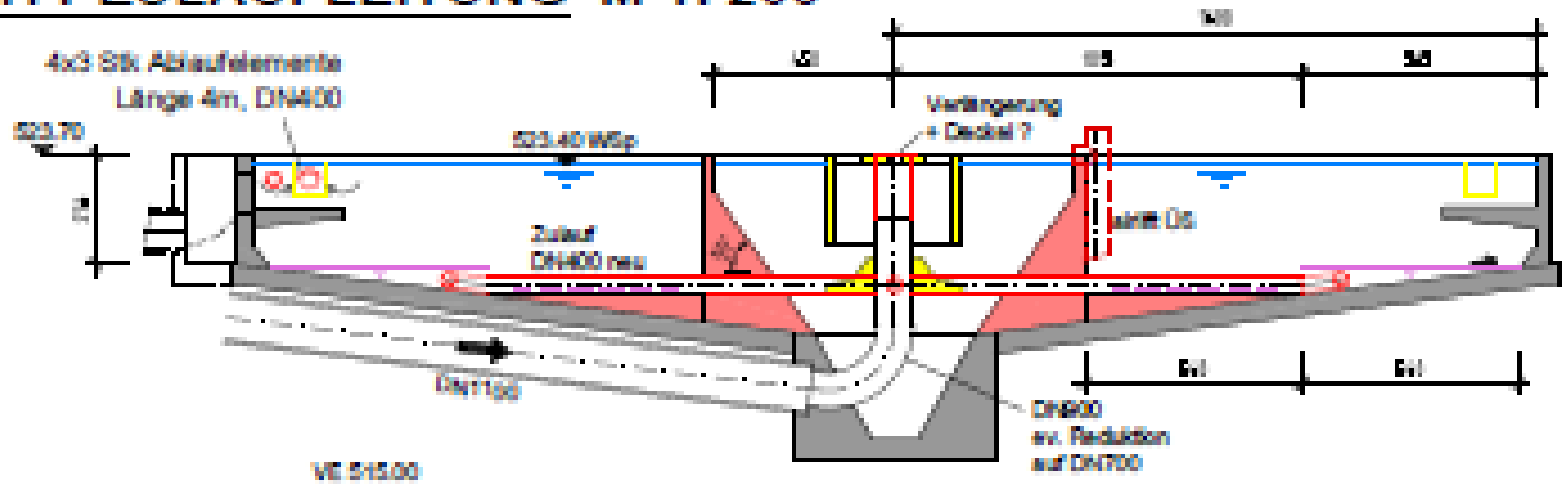

# CFD-modeling of influent distribution

## Base Case

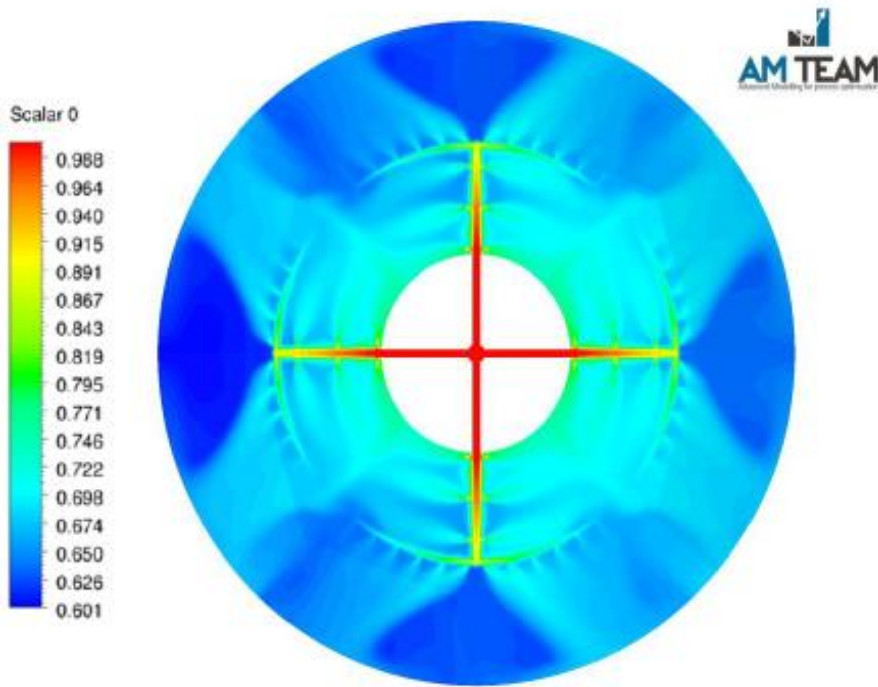

## Scenario 1

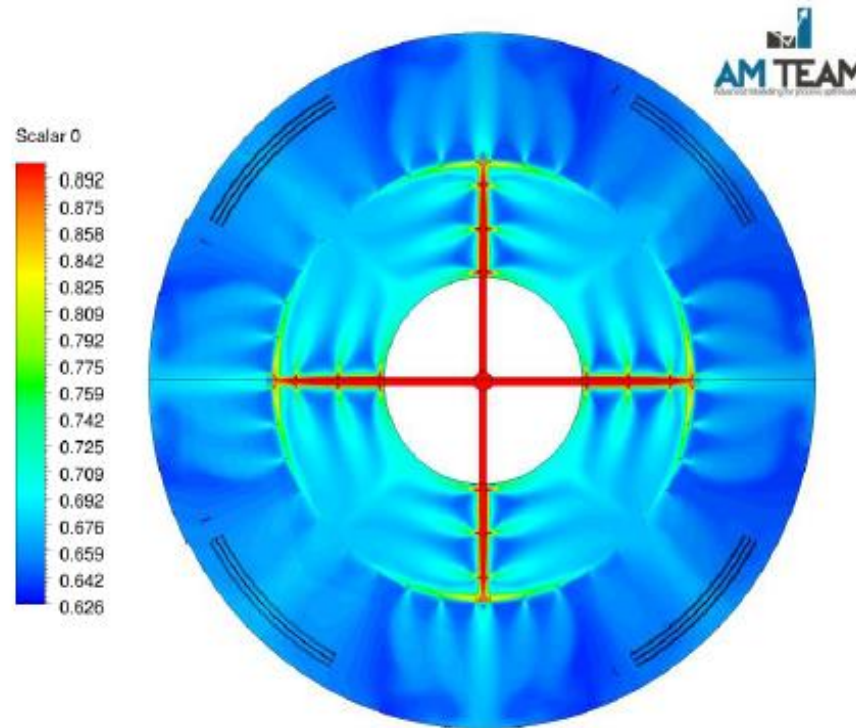

## Scenario 2

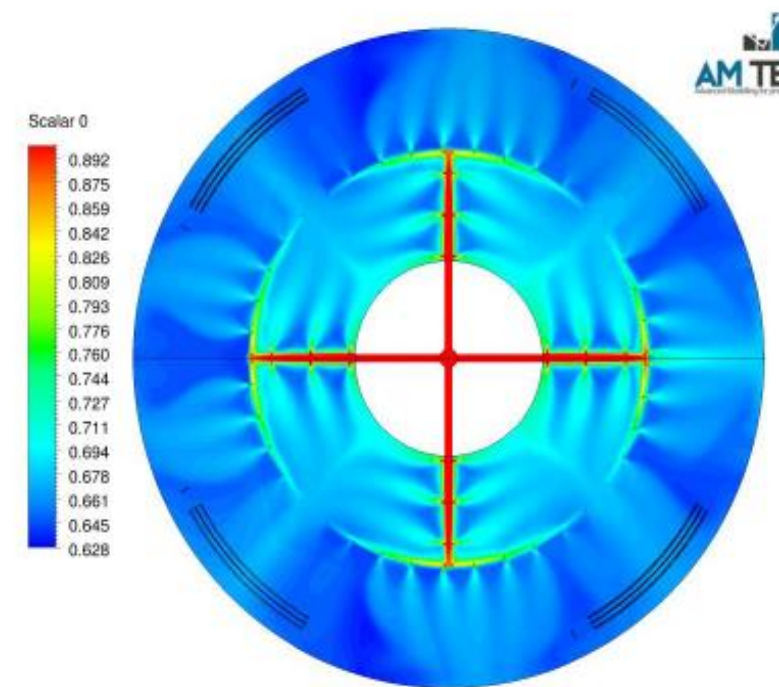

Potential four dead zones



More equally distributed

# Conversion of circular tanks: WWTP Strass, 250000 PE



Diffuser test

# WWTP Strass: start-up results

filtCOD/Pin=17.1

Removal efficiency AAA-Container Strass

filtCOD/Pout=19.0

—●— TCOD —●— TN —●— TP —●— filtCOD

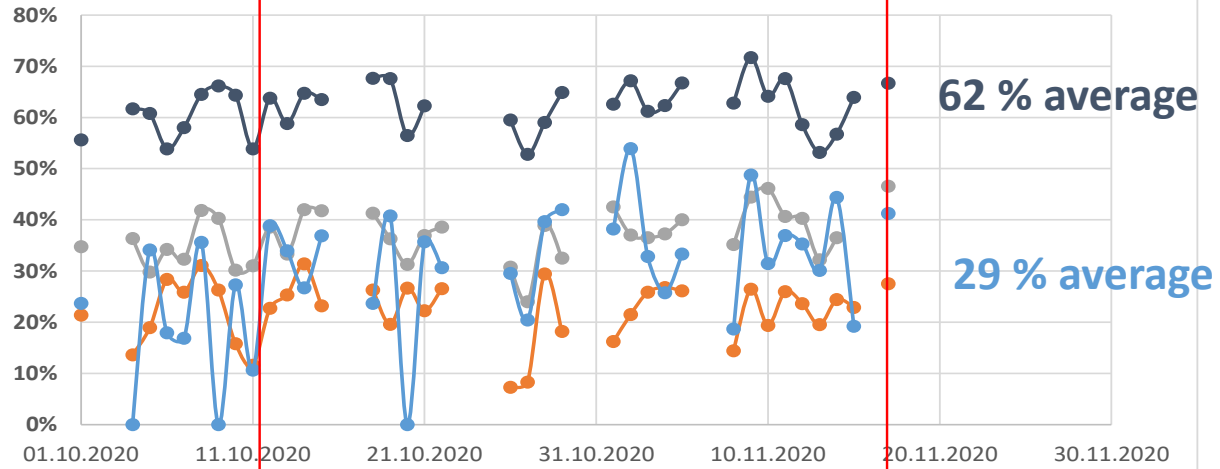

Removal efficiency AAA full-scale Strass

—●— TCOD —●— TN —●— TP

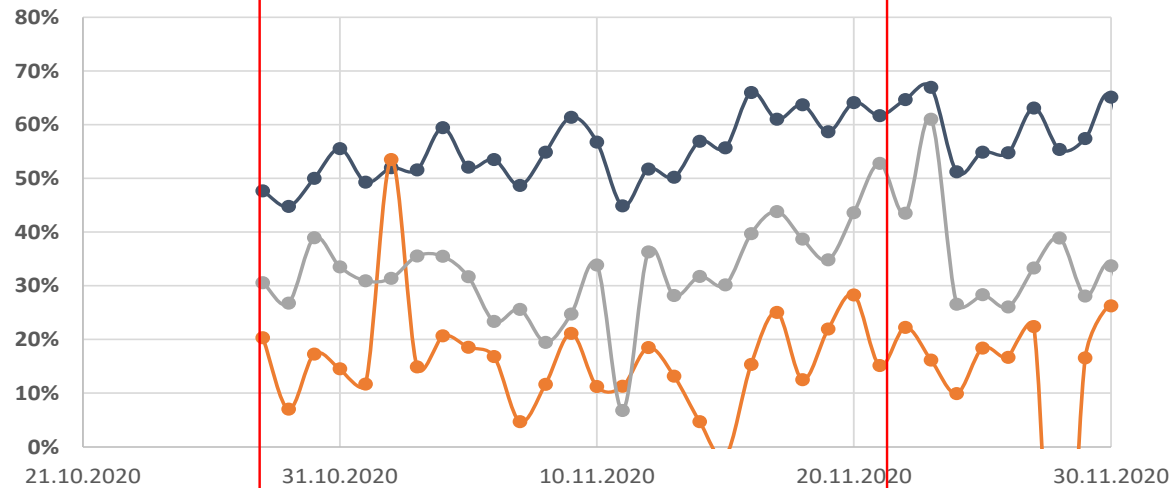

# Anaerobic zones and step-feed for substrate concentration gradients



**PO4-P concentrations**

**NO3-N concentrations**

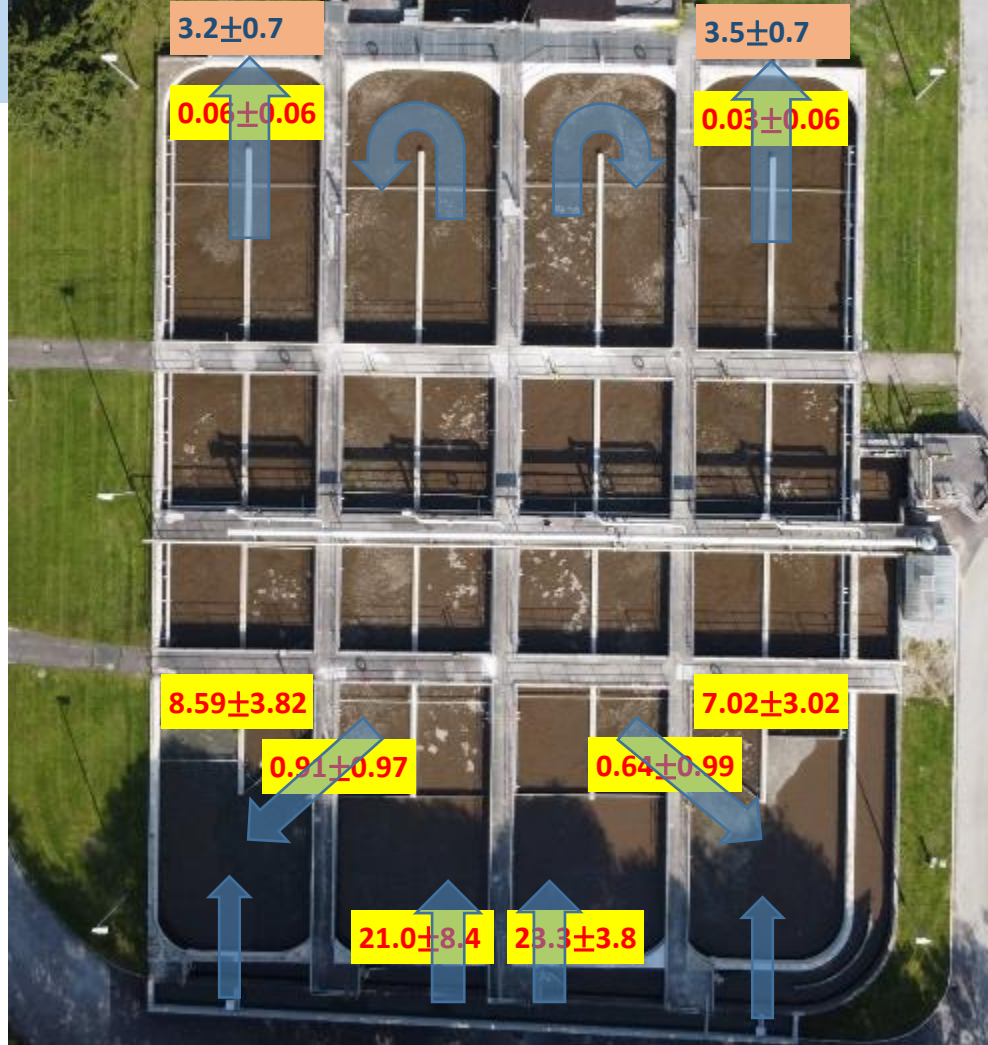

6 grabsamples July/August22 AVERG±STDIV

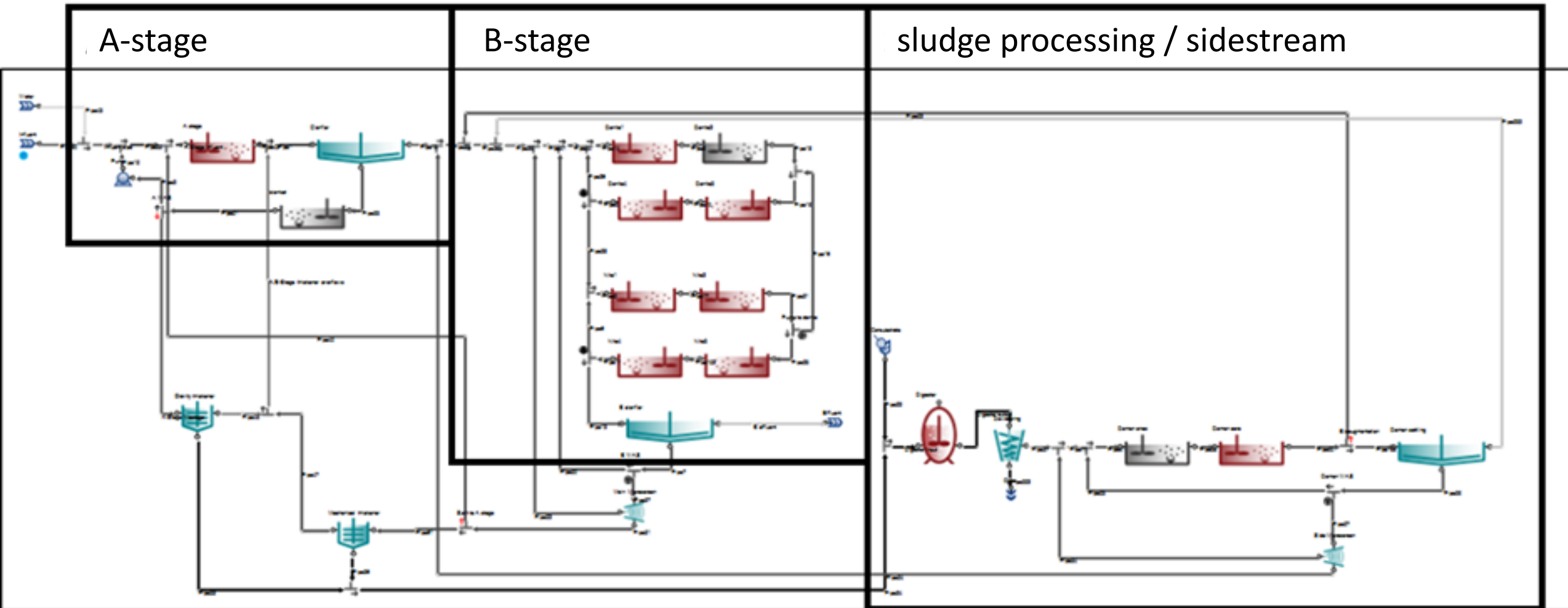

# WWTP Strass: mass-balance and carbon-redirectation

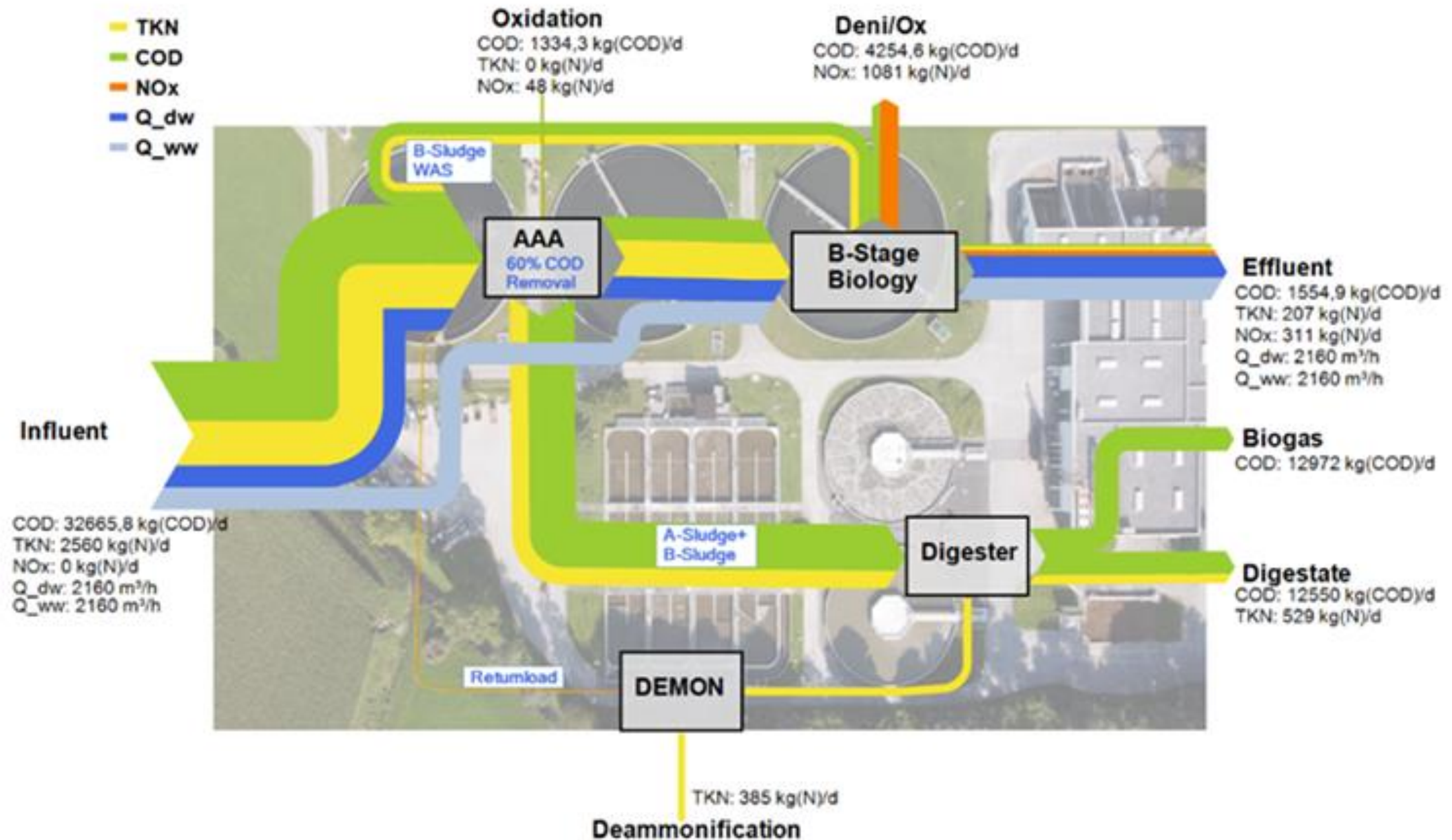



# WWTP Strass: energy-balance and –optimization over 30 years operation period

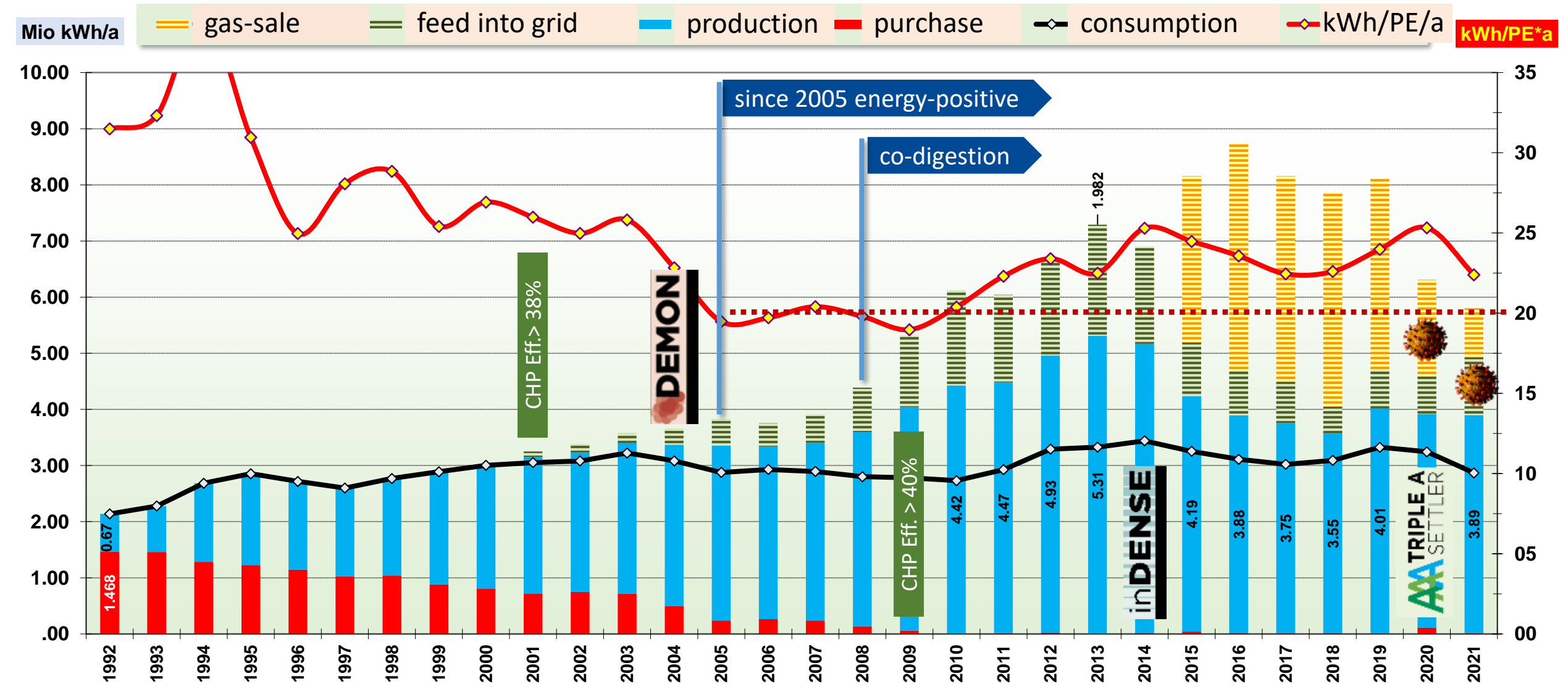

Graphik: plant manager Ch. Fimml

# Conversion-steps AAA-Hallstättersee



# Specific size after retrofit



Plant name	Size [PE]	Tankage [m <sup>3</sup> ]			specific [L <sub>Vol</sub> /PE]	HRT [h]
		A-stage	B-stage	Clarifier		
<b>Strass</b> <i>AAA, DEMON</i> <i>Step-feed, AvN</i> <i>inDENSE</i>	Load: 250.000 PE <sub>COD120</sub> Q <sub>d,DW</sub> : 34.500 m <sup>3</sup> /d Q <sub>h,WW</sub> : 4.320 m <sup>3</sup> /h	A: 4.320 B: 10.456 C: 16.800	A: 17 B: 42 C: 67	A: 3,0 B: 7,3 C: 3,9 (*)		
<b>Alta Badia</b> <i>AAA, Step-feed</i> <i>AvN, inDENSE</i>	Load: 60.000 PE <sub>COD120</sub> Q <sub>d,DW</sub> : 11.467 m <sup>3</sup> /d Q <sub>h,WW</sub> : 956 m <sup>3</sup> /h	A: 960 B: 2.400 C: 3.300	A: 16 B: 40 C: 55	A: 2,0 B: 5,0 C: 3,5 (*)		
<b>Zirl</b> <i>AAA, DEMON,</i> <i>Step-feed, AvN</i> <i>inDENSE</i>	Load: 91.000 PE <sub>COD120</sub> Q <sub>d,DW</sub> : 17.280 m <sup>3</sup> /d Q <sub>h,WW</sub> : 2.160 m <sup>3</sup> /h	A: 1450 B: 8.840 C: 10.340	A: 16 B: 97 C: 114	A: 2,0 B: 12,3 C: 4,8 (*)		
<b>Hallstätter See</b> <i>AAA, Step-feed,</i> <i>AvN, inDENSE</i>	Load: 33.000 PE <sub>COD120</sub> Q <sub>d,DW</sub> : 6300 m <sup>3</sup> /d Q <sub>h,WW</sub> : 648 m <sup>3</sup> /h	A: 696 B: 2.445 C: 2.414	A: 21 B: 74 C: 73	A: 2,5 B: 8,7 C: 3,7 (*)		
<b>Villach</b> <i>AAA, DEMON, inDENSE</i>	Load: 250.000 PE <sub>COD120</sub> Q <sub>d,DW</sub> : 66.942 m <sup>3</sup> /d Q <sub>h,WW</sub> : 7.140 m <sup>3</sup> /h	A: 2.600 (partial flow) B: 26.000 C: 23.088	A: 21 B: 104 C: 92	A: 0,9 B: 9,3 C: 3,2 (*)		

\* Q<sub>h,WW</sub>

- Retrofitting from Primary- to AAA-settlers: Same tankage (HRT=2h) and hydraulic profile (constant level)
- Intensification case-studies with 50% capacity increase
- Energy-self-sufficient plants
- Easy maintenance – AAA without mechanical equipment

**Thank you** to the audience and also some **Buzz-Questions**

- **Does the AAA-process remind you to an HRAS- or an Contact-Stab-process?**
- **What is your opinion about the design-base for enhanced pre-treatment process?**
- **At what COD/N ratios you would apply such a process?**

# WWTP Strass: Dry weather peak design-flow

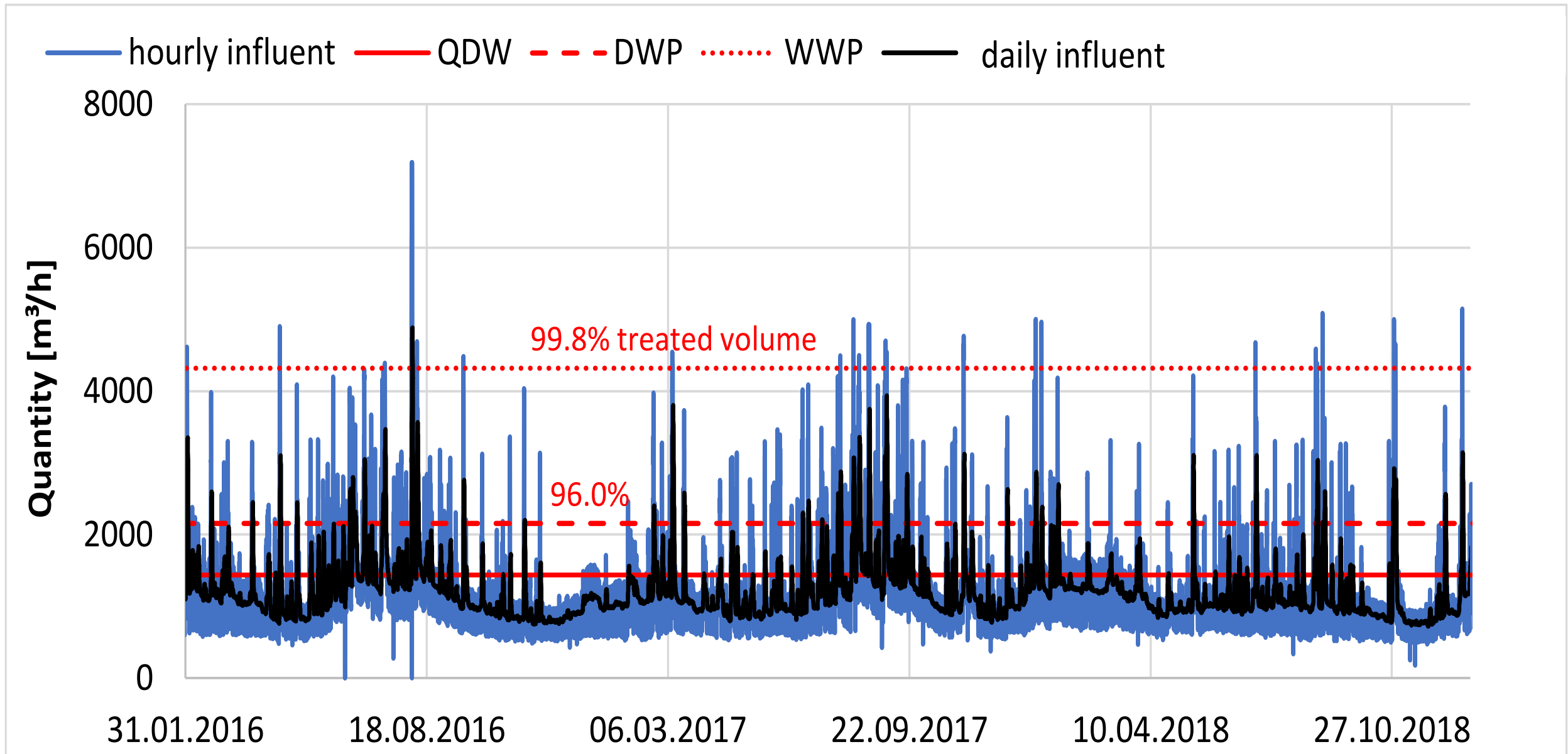

## COD/N ratio

A/B configuration captures more organics and therefore more gas and return-N (compensated by sidestream process).

### Conventional scheme PT + AS

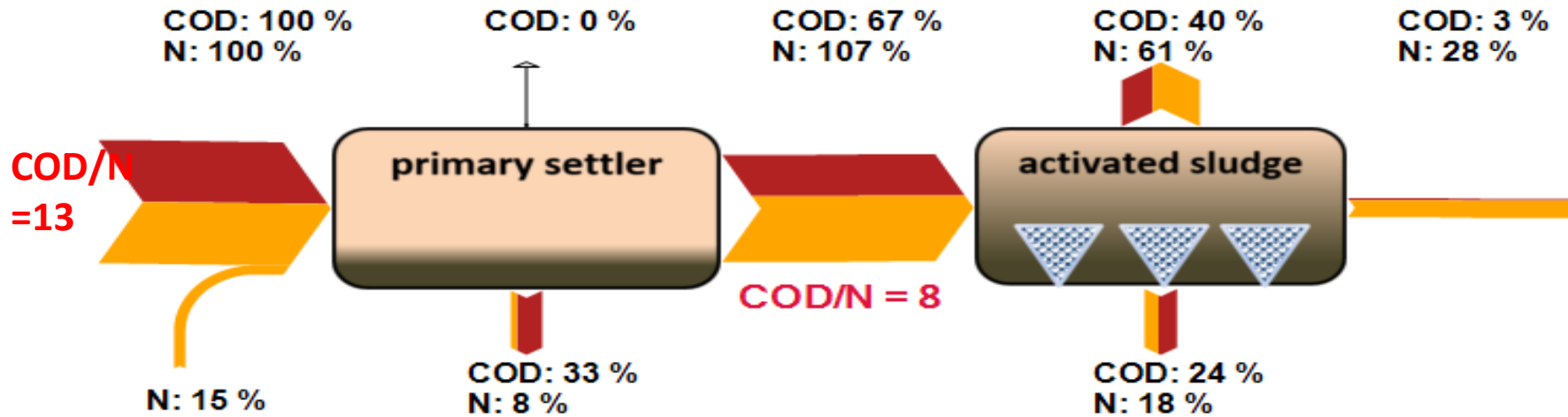

### A/B scheme + sidestream treatment

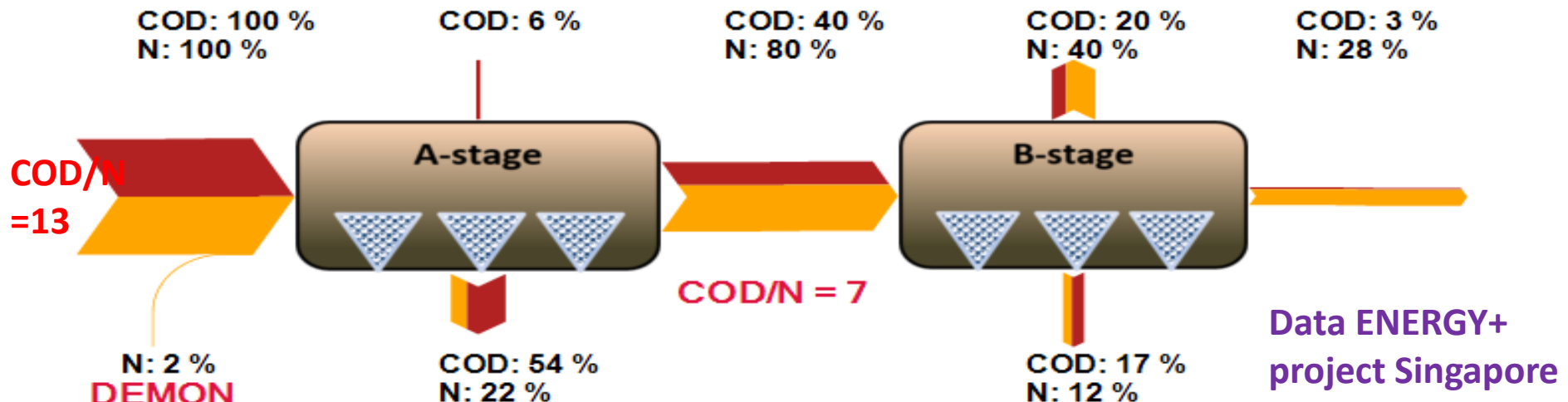

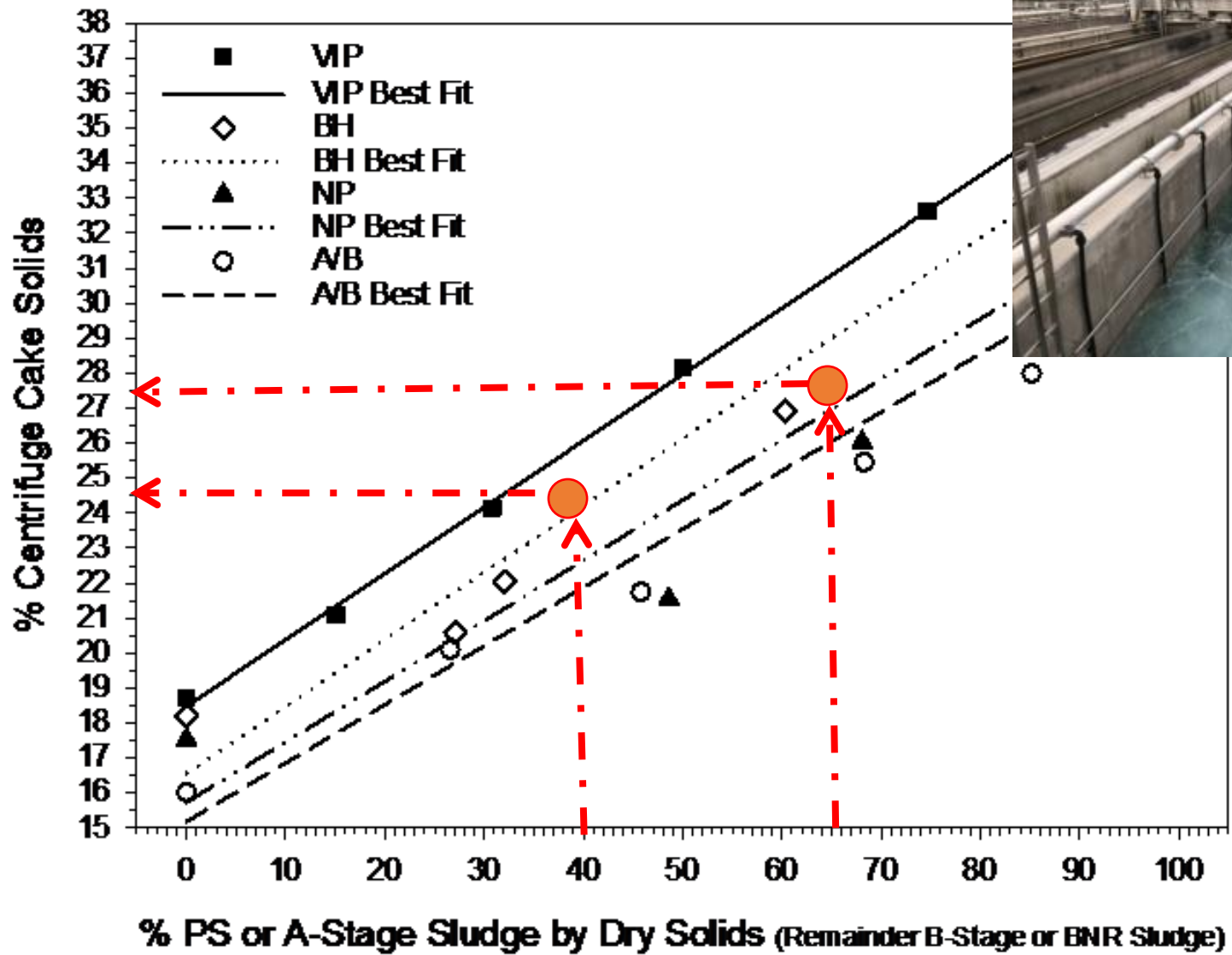

**Improved dewaterability – A/B-plant Bludenz 110000 PE, Austria (2017)**